

# PACK RATS



# CHEESE BITS



**PACK RATS**

CLUB CALL: W3CCX

MT. AIRY VHF RADIO CLUB, INC.

MT. AIRY VHF RADIO CLUB, INC. PHILADELPHIA, PA (ARNS)

50.2, 145.2, 221.4, 432.03, 1296.3, Repeater - 222.98/224.58 (WR3ACD)

AFFILIATED CLUB: AMERICAN RADIO RELAY LEAGUE

MEETINGS: Third THURSDAY of each month, 8 P.M.

Southampton Free Library, 947 E. Street Rd.  
Southampton, Penna.

VOLUME XVIII

JULY 1976

NUMBER 7

## THE PREZ SEZ ..

I feel most fortunate and lucky to be the incoming president of the Mt. Airy VHF Radio Club, now in its 21st year. Through our outgoing president WA3AXV, Ron Whitsel's fine efforts, many projects are underway and rolling.

The big one is the ATLANTIC DIVISION CONVENTION OF THE ARRL- a joint Delaware Valley Area Radio Club effort including our own W3ZD, W3CL and K3GAS- which will be held at the Ben Franklin Hotel in Philadelphia on July 23, 24, 25, 1976. We hope to see many of you there at that time. Following closely is the clubs Expedition to Barranquilla, Columbia, S.A. for the first EME signals from that continent on or about August 1st. Those of you with 20 meter capabilities, listen for the liason traffic with W3KKN/W3TNP. The special call sign given by the Columbian government for use by the Dxpedition is HK1TL (tiera-luna for earth - moon).

Other upcoming club event is the Pack Rat Picnic to be held at Ft. Washington State Park in Flourtown, Pa. on August 8th. An open invitation is extended to all area clubs, their members and families to join us for a free and easy day in the country.

Special plaudits go to Bill Olsen, W3HQT for his outstanding efforts in leading and guiding the club during the June VHF QSO Party at Hilltown, Pa. on June 12 and 13. The complete tallies are not in but the score should be way, way up there. How about that opening to six land.....

Many new projects are being planned and as it is said, "you want a little action"... well, come on out and join in the swing of things; come to the meetings; learn and see what the VHF bands are all about-- there is so much more to VHF than 2 meter FM!

This being our first 'Prez Sez' column, our legs may not be too steady.. So any inputs you might have on programs, projects, pet peeves or special gripes will be tended. So until next month, Bon fortuna y adios amigos - a little practice for HK1TL.

73 fm Lee K3MXM

\*\*\*\*

### Voted to membership

WA3NUF, Phil Miguez  
201 Durham Rd. Apt. J-6  
Penndel, Pa. 19047  
215-757-0814

WB3AOP, Bolmar Aguilar  
XYL- Margarita  
8517 Algo Ave.  
Phila., Pa. 19152  
215-742- 2359

### Visitors at June 17th meeting

Larry Fickett (KSX7936), Abington React #77 - Ardsley, Pa.  
Al Bubris, Jr. (KWP5301) " " Treas. - Roslyn, Pa.  
C.G. Bacon, W3VOI - Norristown, Pa.  
John R. Gordon, WB3CIP - Phila., Pa.  
Phil Miguez, WA3NUF - Penndel, Pa.  
Bolmar Aguilar, WB3AOP - Phila., Pa.

Pack Rats CHEESE BITS is a publication of THE MT. AIRY VHF RADIO CLUB, INC. Philadelphia, Pa. and is published monthly.

Subscription Rate - \$1.50 per year.

We operate on an exchange basis with other publications. Anything that is printed in CHEESE BITS may be reprinted, unless otherwise stated, provided that proper credit is given.

SWAP SHOP ITEMS - no charge.

DEADLINE FOR ARTICLES IS THE GENERAL MEMBERSHIP MEETING.

EDITOR:

W3CL, Harry B. Stein  
2087 Parkdale Avenue  
Glenside, Pa. 19038  
215- TU7- 5052

PUBLISHER/SUBSCRIPTION MANAGER:

K3GAS, Doc Cutler  
7815 New Second Street  
Elkins Park, Pa. 19117  
215- ME5- 1078

PRINTER:

K3IGX, Richard Boyle  
7915 Bayard Street  
Philadelphia, Pa. 19150  
215- 927- 6471

TYPIST:

WA3TEM, Marsha Lissauer

\*\*\*\*\*

TRUSTEE OF CLUB CALLS: W3CCX - WR3ACD

W3SAO, Francis Brick  
821 W. Lindley Avenue  
Philadelphia, Pa. 19141  
215- DA4- 7524

AWARDS CHAIRMAN:

W2EIF, Joseph Kilgore  
#5 Sunnybrook Court  
Stratford, N.J. 08084  
609- 783- 9478

CLUB HISTORIAN:

W3SAO, Francis Brick

OFFICERS: 1976 - 1977

PRESIDENT: K3MXM, Lee A. Cohen  
VICE-PRES: W3HMU, Tony Souza  
COR. SECY: WA3NGK, Harry Brown  
REC. SECY: WA3NFV, Danny Mitten  
TREASURER: K3GAS, Doc Cutler

DIRECTORS:

WA3AXV, Ron Whitsel (Ex-Officio)  
K3IGX, Richard Boyle (2 years)  
K3JJZ, Elliott Weisman (2 years)  
W3HQT, William Olsen (1 year)  
W3YXF, Joseph Rushton (1 year)

\*\*\*\*\*

MONDAY NIGHT NETS:

145.2 MHZ 7:30 PM  
50.2 MHZ 8:30 PM  
221.4/224.58 MHZ 9:00 PM  
432.03 MHZ 9:30 PM  
1296.3 MHZ 10:00 PM

NET CONTROL

W2EIF  
W3CL  
K3GAS  
K3IUU  
W2EIF

FRIDAY NIGHT ATV NET:

439.25 MHZ 7:00 PM

NET CONTROL

WA3AXV

PACK RAT REPEATER - WR3ACD - 222.98/224.58  
Churchville, Pa.

\*\*\*\*\*

215-674-0300



**LAFAYETTE RADIO ELECTRONICS**

"Associate Store"

531 Easton Road  
Horsham, Pa. 19044



Bruce Clark



**PENNSYLVANIA  
INSTITUTE OF TECHNOLOGY**

PAUL D. MERCADO - W3FBF

FCC AMATEUR Instructor COMMERCIAL  
LICENSE INSTRUCTION

(215) FL 2-7100  
(215) JA 8-6998

414 SANSOM STREET  
UPPER DARBY, PA. 19082

THOM GOODING, K4LHB  
206 WEST MAPLE AVENUE  
STERLING, VIRGINIA 22170  
703-450-4718

**G & G ELECTRONICS**

JEFF GOLDMAN, K3DUA  
16424 GRANDE VISTA DRIVE  
ROCKVILLE, MARYLAND 20855  
301-948-7388

CALENDAR OF COMING EVENTS

Syllabus by Lee, K3MXM

JULY

- 1 Dominion Day - Canada
- 3/4 VHF SPACE NET CONTEST - This is the first of four weekend contest periods honoring Appolo/Syuz. 6 PM Saturday Nite through 9 PM Sunday Nite.
- 4 HAPPY BIRTHDAY USA
- 5 Harrisburg ARC Hamfest - Indian Echo Caverns between Harrisburg and Hershey, Pa. Just off Route 422-322. Free tailgating space.
- 6 BARCC - Final wrap-up... dinner at 6:30 PM; meeting at 7:30 PM. Casa Conti, Glenside, Pa. All interested parties invited to attend.
- 10/11 VHF SPACE NET CONTEST
- 14 Board of Directors meeting. Location to be announced on Monday evening nets.
- 15 FIRST OUTDOOR MEETING OF THE SEASON - WHITE ELEPHANT SALE AND AUCTION, QTH W3ZD, Zimmermans Gulch - 520 Centennial Rd., Warminster, Pa. Plenty of parking space. Here is your chance to clean up the cellar and help the club. Don't forget to wrap one item as a special surprise. Just sit back and get your laughs as the bidding goes up, up, and away. Refreshments of course. BRING A CHAIR PLEASE. Open meeting to all especially members of area clubs. Fun starts at 8 PM.
- 16 First ATOMIC BOMB exploded 1945.
- 17/18 VHF SPACE NET CONTEST
- 16/18 ARRL National Convention - Denver, Colo.
- 18 First Lehigh Valley Tri-Club Hamfest at the Lehigh Parkway in Allentown, Pa. 10 AM to 5 PM - \$1.00 at the gate - no tailgating fee. Plenty of room for picnics, Fishing for Junior Ops, contests. Talk-in, 34/94 on WR3ACB. Contact Dennis, WA3IMP for further info. 632 N. Howard St., Allentown, Pa.
- 18 WR3ABE 6 meter repeater picnic - Ft. Washington State Park, Flourtown, Pa.
- 20 MOON DAY - Mans' first landing on the Moon - 1969
- 24/25 VHF SPACE NET CONTEST
- 23,24,25 ARRL ATLANTIC DIVISION CONVENTION - Ben Franklin Hotel, Phila., Pa. Fill out your forms and get your money and reservations in early to Doc K3GAS. Space, rooms, banquet seats, luncheons moving right along and will sell out so... don't be left out in the cold.. do it NOW.  
If you are planning to take an FCC test on Saturday at 6th and Market Sts., Phila. Please get an application in to Joe Welch at that address a week ahead.
- 31, Aug. 1 ARRL Roanoke Division Convention, Norfolk, Va.

AUGUST

- 1 W3CCX/HK - The Pack Rats will be on 432 EME from South America in Barranquilla, Columbia. The special call sign to the expedition is HK1TL (Tiera Luna). Look for this call on the 20 meter link to W3KKN/W3TNP.
- 8 PACK RAT PICNIC AND FAMILY DAY - Ft. Washington State Park, Flourtown, Pa. Delaware Valley Chapter QCWA joins us for an old fashioned day in the country to be enjoyed by Hams, their families, kids and all their friends. A special invitation to members of other area clubs to join us on this day. Carl Croce, K3DLS, General Chairman has arranged for games for adults and children - free soda and PRIZES.
- 1 Winchester, Virginia Hamfest, Berryville, Va. (A new site just out of Winchester).
- 15 Delmarva Hamfest at Wilmington College, New Castle, Del. only about one hour away from Phila. Camping available at nearby Glasgow, Del. Free Bingo for the ladies. Talk-in 13/73, 94/94, 75/15. Info from John Low, K3YHR, 11 Scottfield Dr., Newark, Del. 19173.
- 19 SECOND OUTDOOR MEETING OF THE SEASON - QTH Doc, K3GAS, Elkins Park, Pa. Slides, films and special narration by our own W3CL. Wives and YLs invited to enjoy the evening seeing how everyone looked long ago- especially the kids at picnics and other events. Refreshments will be served at this NOSTALGIA NITE.
- 22 Warren Ohio Hamfest.
- 28/29 Computer Fair - Shelbourne Hotel. Atlantic City. N.J. ...page 3 ...

NEW PRODUCTS OF INTEREST TO HAMS

BY Lyn, W3NSI

1. Two Meter FM T/R: Regency has introduced their new HR 312 for 2 meter FM. Power output is rated at 35 watts, and both receiver and transmitter have their own channel switches. This makes it possible to set up a variety of T/R frequencies. Receive sensitivity is .25 mv for 20 db quieting, and adjacent channel selectivity is 75 db. This will help sort out those 15 Khz split channels. Price \$270, 7707 Records St., Indianapolis, Ind. 46226
2. Two Meter Synthesizer: VHF Engineering Co. has just announced their new synthesizer for use with a variety of 2 meter rigs. Frequency range is 140-149, 995Khz in 5 Khz steps. It will replace crystals in transmitters on 6,8,12 Mhz ranges and receiver crystals from 15 Mhz to 45 Mhz. This just about covers everything on the market. Price \$170(kit), \$240(wired), 320 Water St., P.O. Box 1921, Binghamton, N.Y. 13902
3. Two Meter Synthesized T/R: Henry Radio is now selling the Tempo VHF 1 (made in Japan) and Tempo SSB 1, which is an accessory for the above. Frequency readouts are on a 5 digit LED display, and the entire band 144-148 is covered in 5 Khz jumps. Transmitter output is 10 watts, with the repeater splits being automatic. Price \$495, SSB1 \$225.

\*\*\*\*\*

VHF/UHF REPORT

By Jo, W2EIF

The VHF/UHF bands were amazingly quiet up to the June Contest. One would have thought that a lot of stations would have been on testing and trying out the various rigs. There have been some good tropo openings up and down the coast but the activity has not been sufficient to determine how far it extends. I have heard the Norfolk stations very strong on 2 meters with nothing heard from North Carolina.

Six meters sometimes seems dead but if you get on and call CQ or even put out a test signal you may be surprised at what pops back at you. I was testing on 6 the other day and the band seemed dead but raised an S9 Texas station for a nice QSO. The West Coast has been coming through occasionally for some nice contacts. There may have been a good tropo opening to the North East on June 8th as I was able to work K1PXE (Conn) with 5-8,9 signals both ways. Did not notice similiar activity on 6 & 2meters or 220 & 432 Mhz. The K1PXE contact was on 1296 Mhz.

The contest produced the usual activity and as usual some 20 ---- sections were available on 2 meters with several North Carolina and Maine stations available. The only section I did not hear was Vermont. All things considered, the contest was a pretty active period. All bands seemed to be active even late in the contest.

The September QSO Party this year is on the 11th and 12th.. it comes more quickly than you think so plan ahead.

\*\*\*\*\*

# ARRL ROANOKE DIVISION CONVENTION / HAMFEST JULY 31 - AUG. 1 "SCOPE", NORFOLK, VIRGINIA

NORFOLK SCOPE CULTURAL & CONVENTION CENTER

ADV. TICKETS \$2.50

TIDEWATER RADIO CONVENTIONS, INC. BOX 9371  
NORFOLK, VIRGINIA 23505

- FAMILY VACATION AREA

- BANQUET

- YL-XYL PROGRAMS

- INDOOR, AIR COND. FLEA MARKET

ARRL, FCC, MARS, VHF  
AND OTHER PROGRAMS

**HOLIDAY INN.**

**CALL FREE 800-238-5400**

JUNE VHF QSO PARTY REPORT  
by Bill Olsen, W3HQT

As I wake up this morning at 11:30 and stagger up to the shack.. I realize that the June Contest is once again history .. there it is all over my floor .. boxes full of guy ropes, phasing lines, pencils, power supplies, amplifiers, receivers, spare tubes, clothing, converters, log sheets, empty beer cans, half a liverwurst and onion sandwich, microphones, pencil sharpeners, telegraph keys, bug-away lights, and everyone elses everything! There it will all sit too, ( except for the liverwurst and onion sandwich ) until some of the ole energy comes back and I want to ever look at a radio again.

Once again the Pack Rats have pulled off an incredible show of teamwork; operating expertise and dedicated hard work. This years' show was bigger and better than ever. An all time high of 47 Pack Rats, and over 100 visitors (some CB ers' I've heard - must have been quite a shock) came to see the operations on 6 meter CW/SSB/AM/FM, 2 meter CW/SSB/AM/FM, 220 CW/SSB/AM/FM, 432 CW/SSB, 432 MOONBOUNCE (!), 1296 CW, 2304 CW, and FM on 3,5, and 10 GHZ.

Band captains... Ron, WA3AXV(6m), Bill, W3HQT(2m), Dave, WA3JUF(220), Harry, WA3NGK(432), Tony, W3HMU(432 EME), and Danny, WA3NFV(6&2m FM). All deserve a special commendation because there were hardly any equipment breakdowns the whole week end. It seemed to be the smoothest running June Contest ever. Of course there were crack operators at all positions also. Special mention must go to WA3YZC(6m), W3CXU and K2EVW(2m), WA3JUF(as usual 220), K3IUV(432), and our newest Pack Rat, WA3ZRE filling up log sheets on 2m FM along with hosts of others.

The most thrilling episode of the weekend was the 432 EME demonstration Saturday night. It was chilly, partly cloudy; the Moon was full and rising over the trees in the East; Tony, W3HMU was at the key of the worlds most ambitious portable 432 EME station. There was a murmur among the crowd of 50 or so awed spectators; a CBer shook his head in dismay; K3JJZ and WB3AOP were pointing the antenna, an array of 16- 13 element Yagis (see the picture on page 6). A few adjustments were made and then the transmit/receive switch was flipped to transmit. A hush fell over the crowd; the CBer staggered a bit; W3HQT took a big swig of warm beer; the key was pressed and we quickly stood by. A weak but discernable echo was heard. Again the key was pressed- again an echo was heard. No contacts were made on EME due to some difficulties with the transmitter that were not found until after the Moon had set. When you consider that echoes were heard the first time out with a heretofore untried system, the demonstration has to be termed successful. The next time the system will be set up will be at the end of July in Barranquilla, Columbia, S.A., and the boys are very optomistic about the outcome.

Though all the logs are not thoroughly checked over, it looks like our score will be as good or better than last year even with activity on the bands seemingly less than in previous years. Conditions were average to good on 2 meters on up with good signals up and down the coast. The opening to the West Coast Sunday night on 6 meters sure was a shot in the arm.

Special thanks to Jo, W2EIF who was up at the site Friday morning assembling the 220 MHZ antenna system(so what else is new!); Ernie, W3KKN who came to the rescue with spares in the pinch; Joe, W3YXF "the coffee man" and Doc, K3GAS "the doughnut man". Of course thanks and congratulations to all that participated. See you all next year!

\*\*\*\*\*

ANOTHER FAMILDAY AND PICNIC  
REMINDER

by Carl, K3DLS for the Committee

The annual Pack Rat Picnic is not too far away... it is on SUNDAY AUGUST 8. 1976, starts at 10 AM in the Flourtown section of the Ft. Washington State Park. Talk-in will be on 146.52 Mhz FM Simplex and the Pack Rat Repeater - WR3ACD, 222.98/224.58 Mhz.

This is a FAMILY DAY PICNIC. There will be games and prizes for all with the younger 'harmonics' receiving the famous Pack Rat grab bags. Remember, the big Pack Rat Hamfest event is the HAMARAMA on October 3rd while the Pack Rat Picnic is just for fun and relaxation. Other area clubs have been invited to join us so this year in addition to our friends of the DELAWARE VALLEY CHAPTER-QCWA, the MOBILE SIXERS are coming. This will be an opportunity to meet folks you talk to on the air as well as their families. Many bring their picnic lunch and picnic supper to make a full day of it in one of the best, coolest picnic locations in the Delaware Valley. The cost is the same as last year. The \$2.00 per family registration fee provides free soda along with door prizes, bingo, horseshoes, and games for adults and kids. The personal invitation is the most effective means to spread the word. Please talk this event up among your friends and ask them to mee you at the picnic.

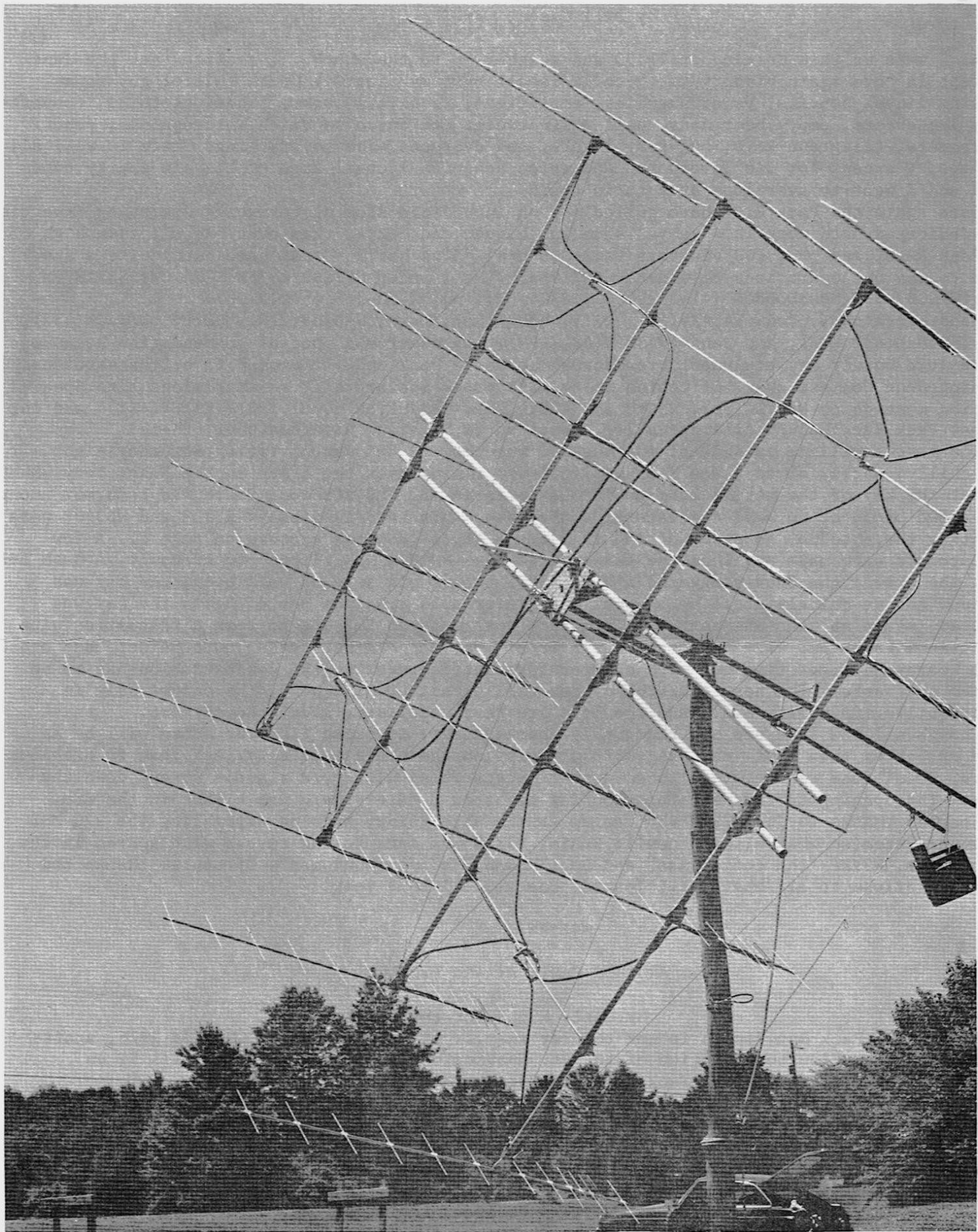

Photo by Dick Boyle, K3IGX

432 MHZ MOONBOUNCE ANTENNA INSTALLATION - HILLTOWN, PA.





# ADS

## MT. AIRY V.H.F. RADIO CLUB, INC.

<p>NE 7-8329</p> <p><b>GEORGE S. VAN DYKE, JR., P.E.</b> CONSULTING ENGINEER</p> <p>W3HK</p> <p>4607 CONVENT LANE PHILA., PA. 19114</p>	 <p><b>AMERICAN RADIO RELAY LEAGUE</b> HARRY A. McCONAGHY, W3SW/W3EPC DIRECTOR, ATLANTIC DIVISION</p> <p>8708 FENWAY DRIVE - POTOMAC BETHESDA, MARYLAND, 20034</p>
<p>609-429-0087</p> <p><b>BRADDOCK ASSOCIATES</b> MANUFACTURERS' REPRESENTATIVE</p> <p>EDWARD BRADDOCK MEMBER: I.E.E.E. W2BAY</p> <p>POST OFFICE BOX 305 HADDONFIELD, N. J. 08033</p>	<p>215-107-9092</p> <p>W3CL</p> <p><b>HARRY B. STEIN ASSOCIATES</b> COMMUNICATIONS CONSULTANTS</p> <p>HARRY B. STEIN</p> <p>2087 PARKDALE AVE. GLENSIDE, PA. 19038</p>
<p>(609) 424-4258</p> <p><b>GREENTREE PRESS</b> Business cards - Envelopes QSL cards - Tickets - etc -</p> <p>1980 GREENTREE ROAD CHERRY HILL, N. J. 08003</p>	<p><b>A request from your AD Manager</b></p> <p><b>PATRONIZE OUR ADVERTISERS</b> Tell them you saw their ad in <b>CHEESEBITS</b>. Leave your QSL card with them. <b>CHEESEBITS</b> is one of the best read local radio club papers. Circulation - 300</p> <p><b>73</b> <b>magazine</b> for radio amateurs</p> <p>1 year - \$10 2 years - \$17 3 years - \$20</p> <p>PETERBOROUGH, NEW HAMPSHIRE 03458</p>

### SWAP SHOP

**FOR SALE:** Model 19 Teletype System, complete.  
Make offer. 40 Watt FL. Light Strips (new)  
\$4.00 each.  
**CONTACT:** W3ZD, Dave Zimmerman  
Phone: 215- 675- 4539

**WANTED:** Rcvr.- for aircraft bands  
**CONTACT:** WA3BKR, Dan Sutton  
Phone: 215- WI7- 2451

**WANTED:** Relatively inexpensive receiver  
to get me back on the air - 80 to 10M.  
**CONTACT:** W3HAV, Lew Klunk  
Phone: 215- 885- 3613

**WANTED:** My 3/8" Craftsman drive & sockets.  
A large rubber handled screw-driver.  
These items borrowed at Hilltown but  
not returned. If you have these items  
**CONTACT:** WA3NFV, Dan Mitten  
Phone: 215- 277- 0972

### ADVERTISEMENT

Bob Hershman, WA3ZID, of "Ham" Buerger, Inc. announces the opening of a second store in addition to the one in Willow Grove, Pa. The new store is located at 33 Main Street, Doylestown, Pa. 18901. Phone: 215-345- 8070. WR3AHC repeaters are now operative on two bands with autopatch capability on both. 2 meters- 147.60/147.00.. 220Mhz. - 222.74/224.24. There is a 4 second delay on these repeaters.

\*\*\*\*\*

ARRL 1976-1977 Repeater Directory is now ready for distribution. An SASE 6 X 9 with 46¢ postage for 1st class, 24¢ for 3rd class.

\*\*\*\*\*

ARE YOU WORKING FOR THAT SPECIAL BICEN AWARD FROM SJRA... WORK THE 13 ORIGINAL STATES ON VHF.

\*\*\*\*\*



# BARRACKS TRADING POST

Camping • Electronics • Canvas

RT. 38 AT RUDDEROW AVE.  
MAPLE SHADE, N. J. 08052

HARVEY PRIMOST  
609-662-6114



**ELECTRONIC CENTER**  
SCHLUMBERGER PRODUCTS CORP.  
OVER 300 ELECTRONIC KITS

**TED HALDIS**  
MANAGER

K3EPK

6318 ROOSEVELT BLVD.  
PHILA., PA. 19149

TELEPHONE  
215 CU 8-0180



**Scott's**  
Surplus  
**Electronics**

134 E. Park Av. Merchantville, N.J. 08109

Division Of dab Associates Inc.

Pres: Scott Layman

609 - 665-2466



AMIL S. GUMULA  
PRESIDENT

**A. G. RADIO PARTS CO.**  
939 TOWNSHIP LINE RD.  
ELKINS PARK, PENNA. 19117  
TELEPHONE: 215 - 886-5100



HOURS  
CLOSED MONDAY  
TUE. & THUR. 9:30-6:00  
WED. & FRI. 11:30-9:00  
SAT. 9:30-5:00

(215) 723-1200  
(215) MI 6-2511

### ELECTRONIC EXCHANGE

ALL TYPES OF HAM GEAR & ELECTRONIC EQUIPMENT  
BOUGHT, SOLD, TRADED & REPAIRED

GORDON R. KITTEL  
K3AIG

136 N. MAIN STREET  
SOUDERTON, PA. 18964

AMATEUR & CB RADIO  
SALES & SERVICE

(215) OL 9-5900

### "HAM" BUERGER INC.

Communication Specialists

BOB HERSHMAN  
WA3ZID

68 N. YORK RD.  
WILLOW GROVE, PA. 19090

Store Hours:  
Mon. Tue. Thu. Fri. 9-5:30 Industrial Sales Division  
Wed. 9-9.. Sat. 9-2 (215) 789-7700

### KASS ELECTRONICS DISTRIBUTORS



DISTRIBUTORS OF  
INDUSTRIAL ELECTRONIC PARTS & EQUIPMENT

Store & General Offices  
(215) 449-2300  
PHILA.: (215) 528-6120

2502 TOWNSHIP LINE ROAD  
(West of Lansdowne Avenue)  
DREXEL HILL, PA. 19026



### J.C. R/C HOBBIES

215/659-0770

Hours:  
Mon. & Sat. 10:00 - 5:00  
Tues. thru Fri. 10:00 - 9:00



### MINIATURE FLYING MODELS

Radio Control Equipment & Supplies  
Crafts for All Ages  
BOATS, TRAINS, CARS & PLANES

23 EASTON ROAD  
Willow Grove, Pa. 19090

JERRY COWAN  
Owner

WA2MWB

CARL BARISH

**MELCO** P.O. BOX 1673  
BELLEVUE, WA 98009  
McINTOSH ELECTRIC COMPANY 206-455-5661



WB9PUJ  
TELEPHONE 219-482-4411  
X6525

RICHARD E. BOKERN  
PRODUCT MANAGER

THE MAGNAVOX COMPANY  
COMMUNICATIONS PRODUCTS OPERATION 2131 COLISEUM BLVD.  
GOVERNMENT AND INDUSTRIAL GROUP FORT WAYNE, IND. 46804

World Wide  Electronics inc.

ELECTRONIC SURPLUS  
CB RADIOS • POLICE MONITORS • CRYSTALS  
ELECTRONIC SYSTEMS • ANTENNAS

Hrs. Wed & Thr. 6 to 10 PM.  
Fri. 12 to 11PM. Sat. 10AM to 11PM.  
Sunday 11 AM to 6 PM.

Store 230 Pennsauken Mart  
Pennsauken, New Jersey 08110

(609) 663-1661

K3MXM

JE 3-4660  
4661

LEE A. COHEN

CLAYTON L. HABY & SON  
INCORPORATED  
4527-31 HEDGE STREET  
PHILADELPHIA, PA. 19124

WIPING RAGS  
POLISHING CLOTHS  
COTTON & WOOLLEN WASTE



W3KKN

ERNEST KENAS  
TOOL DESIGN  
MANUFACTURING ENGINEERING DEPARTMENT

THE BUDD COMPANY  
AUTOMOTIVE DIVISION

PHILADELPHIA, PA.

LOCUST 7-7130

K3KTY

### TRANSPORT EQUIPMENT COMPANY

"Everything for the Truck"

JOHN A. TATE  
PRESIDENT

2215 - 2217 RACE STREET  
PHILADELPHIA, PA. 19103

People who look for peace get it.

—Guru Maharaj Ji

For information contact:

DIVINE LIGHT MISSION (DUO)  
6037 Overbrook Ave.  
Phila., Pa. 19131  
Office: 215- GR 7- 2800

### PATRONIZE OUR ADVERTISERS

Tell them you saw their Ad in

CHEESE - BITS

FIELD MOWING - EASTERN PENNA.

GROUNDSKEEPING -  
PHILA. AND SUBURBS  
INSTITUTIONAL - INDUSTRIAL - PRIVATE  
EQUIPMENT LEASING

PETER H. SHAVNEY  
LANDSCAPING  
111 S. EASTON ROAD  
GLENSIDE, PA.

WA3OVH

896-1859  
OR  
933-0451





# HARMONICS

Publication of the South Jersey Radio Association



Vol. II - Issue 6

JUNE 1976

## THE BICENTENNIAL AMATEUR RADIO CONVENTION



Only one month to go 'til the biggest bash in all hamdom. The ARRL Bicentennial Celebration comes to the place where history was made, Philadelphia as the 1976 ARRL Atlantic Division Convention takes place at the Benjamin Franklin Hotel, July 23, 24, and 25.

Just about every aspect of amateur radio will be on the program during the three day event, from the spark transmitter days to the latest in electronic gear. And that's just inside the exhibit area. As you enter the forums you will hear well known speakers discuss the latest in DX, EME, QRP, and Public Service. Also ARRL and FCC will have their own forums. Several items expected to keep officials busy will be restructuring, bandwidth docket, the preparations for WARC and ARRL will also unveil its plans to increase the number of amateur operators.

There is a fun packed week-end for the gals too! Saturday features a Women's Luncheon with several speakers and a special appearance of the Ferko String Band. So gals bring them golden slippers. The morning and afternoon will be yours to also tour the Olde City or shop the stores.

In the evening you can both enjoy the Saturday Banquet. After dinner everyone can sit back and relax as Admiral Ray Schnieder delivers the keynote address. He is W3MJE. Following dinner, the most sacred of all ham ceremonies will take place at the stroke of midnight, the Royal Order of the Wouff Hong initiation ceremony.

After a big day on Saturday, you'll want to make sure you don't miss the Sunday events beginning at 9 AM. More forums, more eyeballs and to do the things you missed on Saturday.

For Convention information and registration write BARCC P.O. Box 7170 Elkins Park, Pa. 19117

EDITORS NOTE: THE ABOVE PRESS RELEASE WAS PREPARED BY BOB JOSUWEIT, WA3PZO, PUBLIC RELATIONS DIRECTOR FOR THE BICENTENNIAL AMATEUR RADIO CONVENTION COMMITTEE. PERMISSION TO REPRINT WAS OBTAINED FROM OUR OLD FRIEND WALT SCHMIDT, W2EA, EDITOR OF 'HARMONICS'.

## FCC ACTION ON RESTRUCTURING

The FCC has issued a Report and Order on Docket 20282- a first cut which is outlined as follows:

Full Novice privileges for Technician Class licensees.

A Novice reaching the end of his license term can retest for a new Novice immediately; the one year wait is discontinued.

Novices may run 250 watts d.c. power input.

All licensees using the Novice segments of the bands are also limited to 250 watts.

Full credit will be granted for examination elements previously completed by mail.

Conditionals are "grandfathered" to General, Technicians(C) to Technician.

Element 2, the Novice written test, will be part of all exams.

The number of distinct license classes is reduced from 10 to 5 by this action.

The future availability of mail exams is limited to Novices only, except in cases of physical disability( backed up by a physician's statement).

These changes will be effective July 23, 1976.

(The above taken in part from ARRL Directors' letter No. 1628 of June 11, 1976)

Note: If you are coming to the ARRL Atlantic Division Convention in Phila., you will be able to take examinations from Technician class on up at the FCC office on SATURDAY, JULY 24, 1976.

\*\*\*\*

### TID BITS

Our newly elected Prez and his family are off on a cross country jaunt in their newly acquired trailer. Have a pleasant trip folks; that is K3MXM and XYL Peggy and harmonics

Congratulations to Mario, W3ELX on obtaining his advanced class license.

Lee, K3MXM reminds us that when writing to the FCC in Gettysburg to use the special PO Box 1020, Gettysburg, Pa. 17325.

Congratulations to Carl, K3DLS on his election to the office of secretary of Penn ARC. Another Pack Rat, Gregg, WA3UXM is doing a fine job as president of Explorer Post #211, Valley Forge Council. We also would like to extend kudos to Ralph, WA3FOF on his FB job as editor of Penn ARC's, THE KILOWATT.

Philmont's THE BLURB has the most beautiful front cover on their July issue - artistry by Sam Kunceвич, color reproduction by the latest in Xerography... congratulations to their editor, Bob, K3KUD.

You are getting old when you can't make ends meet - the hands and the toes.. de Auto Call.

\*\*\*\*

OFFICIAL BULLETIN NR 592 FROM ARRL HEADQUARTERS NEWINGTON CT JUNE 3 1976 TO ALL RADIO AMATEURS BT In a Public Notice released June 3, 1976 the Federal Communications Commission announced approval of ARRL's Petition for Extension of Time in Docket 20777. This proposal, known as the bandwidth docket, would eliminate all mode restrictions from the amateur rules, and replace them with maximum bandwidths that may be used on various portions of the amateur bands regardless of the form of emission used. The new deadline for filing comments is August 4, 1976, with reply comments due September 3, 1976. Comments, with 11 copies if possible, should be sent to the FCC, Amateur and Citizens Division, Washington, DC 20554. Don't forget to send a copy to your ARRL director, whose address can be found on page 8 of QST. AR

\*\*\*\*

Good wishes to our newly elected officers and directors. Thanks to the outgoing crew headed up by Ron, WA3AXV for a job well done.

Congratulations to Dan Sutton, WA3BKR (Delmont Radio Club) on his aviation solo certificate dated June 17, 1976. Dan is preparing the Atlantic Division Convention Program Book.

RTTY ANTHOLOGY (PART 4)  
by Ralph Alexander, WA3FOF  
RECEIVING

One of the first things most people want to do after the acquisition of a teleprinter is to try to receive something off the air and several things are needed to accomplish this.

First, a very stable HF band receiver, preferably one with single side band capability. Next, a device called a Terminal Unit (TU) or RTTY converter. This unit is required to process the receiver output which is usually the audio at the speaker terminals. The RF from the last IF can also be used but most people will be using an audio TU. If an audio TU is used, a "T" pad is needed. An inexpensive pad may be an automobile front and rear speaker fader control. It is good practice to hear the RTTY tones and the fader control will allow the RTTY tones to be monitored at a comfortable level from the speaker; providing a reasonably constant signal to the TU. The input impedance of most Terminal Units is 600 ohms so one will need a matching transformer providing 8 ohms (speaker impedance) to 600 ohms. It is important to make this impedance match in order to prevent overloading the receiver audio. The circuit is shown on Figure 1.

The first stage in a TU is called the limiter which helps to even out variations in the output of the receiver. The next stage contains the channel filters which is the heart of the TU. Many devices were used for these audio filters such as small audio filter chokes and even television width coils. However, the filters that work the best are 88 milli-henry toroids. The "Butterworth Filter Circuit" uses three toroids per channel. The three channels are as follows: 2125 Hz for common MARK; 2295 Hz for 170 Hz shift SPACE; and 2975 Hz for 850 Hz shift SPACE with a switch to select between the two shifts. (Figure 2.) There are other ways of providing channel filters called "Phase Locked Loops" and the circuit changes can be made in the TU. This is not recommended for one getting started in RTTY.

To align each channel filter, use a calibrated audio generator fed to the filter with an AC VTVM to read the output of the filter, or use a receiver with a 100 KHz calibrator. Adjust the receiver BFO to produce the audio frequency fed to the filter with an AC VTVM and a frequency counter at the output of the filter. The tuning is done by the substitution of several good quality capacitors (Mylar, silver mica but not paper) added in parallel across the 88 mh. toroid until a sharp peak at the desired frequency is obtained. Tune each of the channel filters first and then build the components into the TU.

The next item that would be useful is a double-throw switch at the output of the channel filters. This switch will serve to flip over the output MARK and SPACE signals from the channel filters in case they are received inverted. (See Figure 2.)

The signal then travels to the keyer circuit using a tube with low plate resistance such as a 6Y6 or 6AQ5. Of course this circuit may be transistorized..... When a signal comes thru the TU, the keyer tube is biased to cut-off and no current flows; a SPACE condition. With no signal thru the TU; a MARK condition, the keyer tube is not biased and draws 60 ma. plate current (Max)

It is best to run the output of the keyer directly into a polar relay since the tube or transistor will have trouble handling the inductive reactance of the magnets of one machine. It is not possible to run two or more machines in series.

When starting out it is best to use a scope to tune the RTTY signal; any type scope will do. Connect the vertical plates to the output of the MARK filter and the horizontal plates to the output of the SPACE filter (the switch point shown in Figure 2.) Adjust the scope vertical and horizontal gain controls, with the internal sweep turned off, to obtain a cross pattern in order to tune in or monitor the RTTY signal. (continued next month)

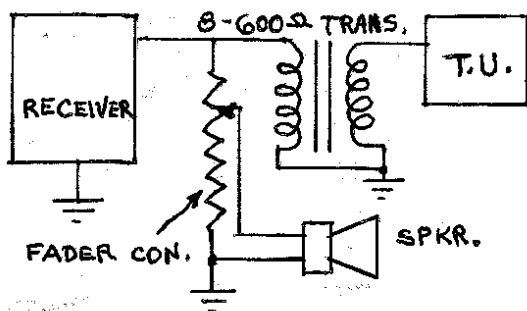

FIG. 1

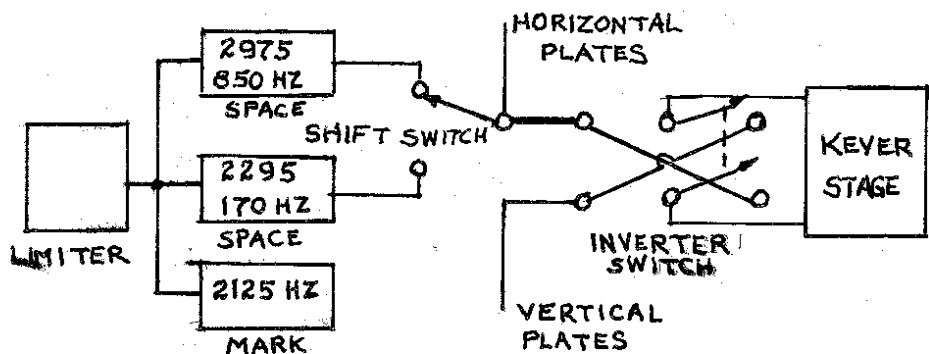
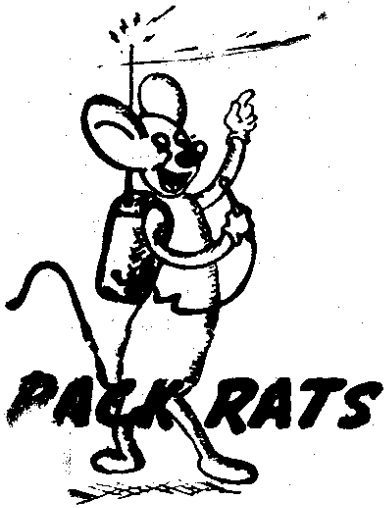
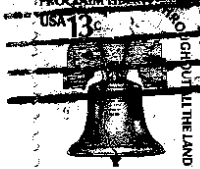
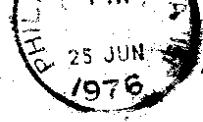

FIG. 2

Cheese Bits  
2087 Parkdale Ave.  
Glenside, Pa. 19038



W3FQD Dick Huntzinger  
130 Fairhill Drive  
Churchville, Pa. 18966

MT. AIRY VHF RADIO CLUB, INC.

FIRST CLASS

MEETING NOTICE

# "HAM" BUERGER INC.

AMATEUR RADIO EQUIPMENT PARTS & SERVICE

68 N. YORK RD.  
WILLOW GROVE PA. 19090  
(215) OL 9-5900

HOURS:  
MWF 9:30 to 9:00  
TThS 9:30 to 5:30

THESE BRANDS  
AND MORE

Bob Hershman, WA3ZID

BUY TRADE SELL on CONSIGNMENT



for radio amateurs

LMB

"W2AU" BALUN

