

PACK RATS'



PACK RATS

CLUB CALL: W3CCX

CHEESE BITS



MT. AIRY VHF RADIO CLUB, INC. VHF RADIO CLUB, INC., PHILADELPHIA, PA.
 50.125, 144.50, 432.110, 1296.025 Mhz, WR3ACD - Repeater 222.98/224.58 Mhz
 Affiliated Club: AMERICAN RADIO RELAY LEAGUE
 Meetings: Third Thursday of each month at 8:00 P.M.
 Southampton Free Library, 947 E. Street Road
 Southampton, Pennsylvania 18966

ARNS

VOLUME XXII

DECEMBER, 1980

NUMBER 12

THE PREZ SEZ

As we go into the winter season we see that the Sun has continued to bless the 6 meter scene. It's been a lot of fun to work Europe again this year and to enjoy west coast DX with S meter pinning signals. Hope you've been enjoying the fun and that it lasts a while longer. Congratulations to N3AHI and WA3AXV for their vigilance in monitoring the band - it paid off with a WAC for both of them. Hard work and observation of the band and its' changing conditions along with a wee bit of luck were the keys to their success.

With a little over a month to go, the January VHF SWEEPSTAKES looks awfully close. Are you ready? I'm sure that our competitors are and we won't be able to come thru again this year without a big effort - the competition will make us hard working winners or "it's just another contest" also rans. It's our decision on which ones we will be. Check with your coordinator if you need help or can provide help for others of the Pack-Rat clan. There's still time for antenna work and consider replacing your coax - especially if its RG8 and more than two or three years old. Remember that coax loss, like antenna gain, affects you on both transmit and receive.

Best wishes during the upcoming holiday season. Hope you'll be keeping warm this winter by gathering round the linear with microphone and key.

73, Harry, W3IIT

NOTICE

A CONVERTER AND PREAMP TUNE-UP SESSION IS SCHEDULED FOR THE EVENING OF WEDNESDAY, DECEMBER 3, 1980 AT THE HOME OF STEVE SIMONS, WA3WAS. HIS QTH IS 435 IVY STREET, WARMINSTER, PA. FOR DIRECTIONS FONE STEVE AT 215-672-6486. BILL OLSON, W3HQT WILL BE AVAILABLE ALSO FOR CONSULTATION AS WELL AS PROVIDING THE NECESSARY TEST GEAR.

Pack Rats CHEESE BITS is a publication of
THE MT. AIRY VHF RADIO CLUB, INC.
Philadelphia, Pa. and is published monthly.

SUBSCRIPTION RATE - \$2.00 PER YEAR

We operate on an exchange basis with other
publications. Anything that is printed in
CHEESE BITS may be reprinted, unless other-
wise stated, provided that proper credit
is given.

SWAP SHOP ITEMS - NO CHARGE

DEADLINE FOR ARTICLES IS THE GENERAL
MEMBERSHIP MEETING: THE THIRD THURSDAY
OF THE MONTH

EDITOR:

W3CL, HARRY B. STEIN
2087 Parkdale Avenue
Glenside, Pa. 19038
215-887-5052

PUBLISHER/SUBSCRIPTION MANAGER:

K3GAS, DOC CUTLER
7815 New Second Street
Elkins Park, Pa. 19117
215-635-1078

PRINTER:

WA3FOF, RALPH ALEXANDER
215-276-4185

TYPIST:

WA3TEM, MARSHA LISSAUER

TRUSTEE OF CLUB CALLS (W3CCX-WR3ACD):

WA3AXV, RONALD WHITSEL
215-355-5730

AWARDS CHAIRMAN:

W2EIF, JOSEPH KILGORE
609-783-9478

CLUB HISTORIAN:

W3CL, HARRY B. STEIN

<u>MONDAY NIGHT NETS</u>	<u>NET CONTROL</u>
7:30 PM - 50.125 MHZ	W3CL
8:00 PM - 144.150 MHZ	W2EIF
8:30 PM - 222.98/224.58	K3GAS
9:00 PM - 432.1 MHZ	K3IUU
9:30 PM - 1296.025 MHZ	W3CXU

PACK RAT REPEATER 222.98/224.58 MHZ
LOCATED IN CHURCHVILLE, PA.

OFFICERS: 1980-1981

PRESIDENT: W3IIT, HARRY BROWN
VICE-PRES: WA3JUF, DAVE MASCARO
COR. SECY: WA3WAS, STEVE SIMON
REC. SECY: K3IGX, DICK BOYLE
TREASURER: K3GAS, DOC CUTLER
DIRECTORS:

W3HQT, BILL OLSON (Ex-Of)
WA2DPU, BILL SMITH (2yrs)
K3NHX, JOE GARDOCKI (2yrs)
N3AHI, JIM HOLT (1yr)
WA3NFV, DAN MITTEN (1yr)

FREE ESTIMATES
(215) 672-3850
(215) 822-0808



MICHAEL McMAC

REGISTERED PLUMBING & ELECTRICIAN
BATHROOM INSTALLATIONS • ELECTRICAL • CLEANING

96 HELLBERG AVE.
CHALFONT, PA. 18914

2405 PARKSIDE E.
HATBORO, PA. 08840

1-302-478-2757

**AMATEUR
and
ADVANCED
COMMUNICATIONS**



G. B. WALLS

3208 CONCORD PIKE (RT. 202)
WILMINGTON, DEL. 19803



**PENNSYLVANIA
INSTITUTE OF TECHNOLOGY**

PAUL D. MERCADO - W3FBF
FCC AMATEUR Instructor COMMERCIAL
LICENSE INSTRUCTION

(215) PL 2-7100
(215) JA 8-6998

414 SANSOM STREET
UPPER DARBY, PA. 19082

MAKE A GOOD MARRIAGE GREAT!

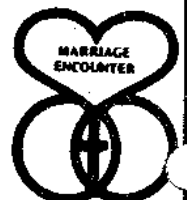

ASK US ABOUT OUR WEEKEND.

TONY AND JAN DOUG AND WENDY
W3HMU WB3KES
HARRY AND ROSE DAN AND LUCY
W3IIT WA3NFV

CALENDAR OF COMING EVENTS
Syllabus by Lee, K3MXM

DECEMBER

- 1 Get started on your shopping now. Beat the rush.
- 2-10 Happy Chanukah - (Jewish Festival of Lights)
- 5 A memorial day for you oldsters - Prohibition repealed - 1933
- 6-7 ARRL - 160 Meter Contest - Rules - November QST Page 92
- 7 Pearl Harbor Day - who can forget where they were on this one date.....
- 11 Board of directors Meeting - QTH - K3MXM, Lee A. Cohen, 8242 Brookside Road, Elkins Park, Pa. 19117. If lost, 635-4942. Directors and interested parties always invited.
- 13-14 ARRL - 10 Meter Contest - Rules, November QST Page 92
- 18 Closed Club Meeting - For Members Only. All urged to attend. Final preparations for the Contest - Pick up your packages. Bring pencils and pads. Get help for your station. Arrange equipment exchange. The Mario Raffle - Frankie's Silent Auction - Refreshments.
- 25 Merry Christmas - To one and all!
- 28 Canada Contest
- 29 For you Zane Grey Buffs - Wounded Knee Massacre - 1890
- 31 Straight Key Nite
- 31 Happy New Year
Midnite

* Jan. 17-18 *
*THE CONTEST *

* * *

VISITORS AT THE NOVEMBER 20, 1980 MEETING

K3ZKO - Ron Cohen, Cheltenham, Pa.
W3AJS - Ed Keener, Oreland, Pa.
WB3EFO - Ed Lee, Huntingdon Valley, Pa.
Ex W3FKZ - Ed Miller, Oreland, Pa.

WB3FEH - Bob Rhoads, Churchville, Pa.
W2FVJ - Lou Shore, Mt. Laurel, N.J.
W3ICC - Drex - Wycombe, Pa.

VOTED TO MEMBERSHIP

WB2RVX - Dr. Michael F. Gullo (Mike)
3813 Delaware Avenue
Pennsauken, N.J. 08109
609-663-2725

WB3JYO - Paul Drexler
P.O. Box 73
Wycombe, Pa. 18980
215-598-3934

CHANGE OF ADDRESS

W1JPM/8 - Stanley Smith XYL Barbara
22 Battles Road
Gates Mills, Oh. 44040

W3UXM, Greg Adams XYL Donna
1070 Easton Rd., Apt. #6
Roslyn, Pa. 19001
215-886-5179

NEW PRODUCTS OF INTEREST TO HAMS

By Lyn, W3NSI

1. 1296 MHZ LINEAR SSB TRANSVERTER: The new MMT 1296-144 is designed to operate on 1296 using a 144-146 rig such as the Kenwood TS 700 as the IF unit. Output on 1296 is rated at 1.3W. and receiver noise figure is 2.5 db. Unit is composed of two cast aluminum boxes, one on top of the other for a total size of 7 1/2" x 5" x 4 1/2". One box contains the receive converter, other contains the LO, transmitter up converter, and amplifier. PIN diode S/R is used controlled by internal VOX or external over-ride. Price \$415.95. Spectrum International, Inc., P.O. Box 1084, Concord, Mass. 01742
2. DIP METER: The new Kenwood DM-81 is now stocked in Ham outlets. The frequency range is 700 KHz to 250 Mhz in seven ranges using plug in coils. These coils plus capacitive probe and earphone can be carried inside the unit. It can also be used as a crystal checker for FT 243 or HC 25 type crystals. Price \$100.
3. VARIABLE CURRENT CIRCUIT BREAKER: The model 101 Breaker box is designed to be used on low voltage DC circuits to protect equipment during tests etc. Five switches on the panel can be used to set the trip current at 250 Ma to 7.75 amps in 1/4 amp increments. Unit is rated to trip in 10 milliseconds. Trip condition is indicated by an LED. Circuit is reset with a push button. Price \$49.50. Long Wave Co., P.O. Box 911, 4934 Santa Maria Dr., Amado, Ariz. 85640.

* * *

VHF/UHF REPORT

By Joe, W2EIF

The VHF/UHF bands seem to be in the normally low activity period that usually sets in with the colder weather. The Tropo conditions for long haul contacts have just about shut down until next Spring. There are still good contacts to be made out to 350 miles or so. One can usually find W8HEG Bob on the low end of 2 meters almost nitely. I suspect the long haul thrill of working VHF/UHF stations is limited to a few who can put up big antennas and run high power.

The six meter band is producing some good results on F2. As expected, the band started opening to Europe about the middle of October. There were the usual crossband 10 to 6 openings in the AM plus direct contacts with the EI6 boys and EL2AV in Liberia. These contacts were spotty and were taken advantage of by WA3AXV and N3AHI to earn their WAC certificates on 6 meters.

The early part of November began to produce good afternoon openings into the West Coast. The signals as they did last year would work up the coast and Alaska stations started to appear about November 6. That date yielded an opening from the West Coast to Japan. Alaska was in on November 8 as far West as Kodiak Island. November 8 to November 13 yielded good West Coast opening and November 13 was peculiar in that only Alaska stations (4 heard here) were coming thru. On November 14 the band again opened to NW and on November 15 there was a reported contact with a ZL2 by WA2VUN and EI9D was worked by W3KKN. November 16 yielded EI9D for W2EIF. No observations from here on the 18 and 19. The 20th produced an opening to Calif., Oregon and Washington and VE7 land. The West Coast stations were excited about LU-3's and 7's, being heard and called. No backscatter could be detected here. The activity is about as predicted. The F2 opening period will apparently be shorter than last year and should conclude in the next week or so. So you people that missed out will have to wait another 11 years!!!

* * *

TID BITS

There was a problem in printing the photos last month - they were rerun and are included in this issue.

(CONTINUED ON PAGE 7)

EXTERNAL KEYING CIRCUIT FOR ICOM-IC-551

by Steven M. Simons, WA3WAS

This modification to the ICOM-IC-551 will provide a high current keying circuit for external amplifiers. The circuit provides a ground when the rig is in the transmit mode. The assembly can be glued in place on the bottom of the rig with a dab of RTV silicone seal.

The connections for power, ground and keying voltage are taken from the accessory socket on the back of the rig. The relay output is connected to the spare jack on the upper right hand corner of the rig. The parts list is as follows:

- | | |
|--|---|
| 1 - TIP-31A Transistor TR1
(any NPN audio power device will work) | 1 - .001uf Disc Capacitor C1 |
| 2 - 1000V 1A Silicone Diode D1,D2 | 1 - .01uf Disc Capacitor C2 |
| 1 - 12V Miniature Relay RL1 | 3 - Pins(gold plated) to fit in the
accessory socket |

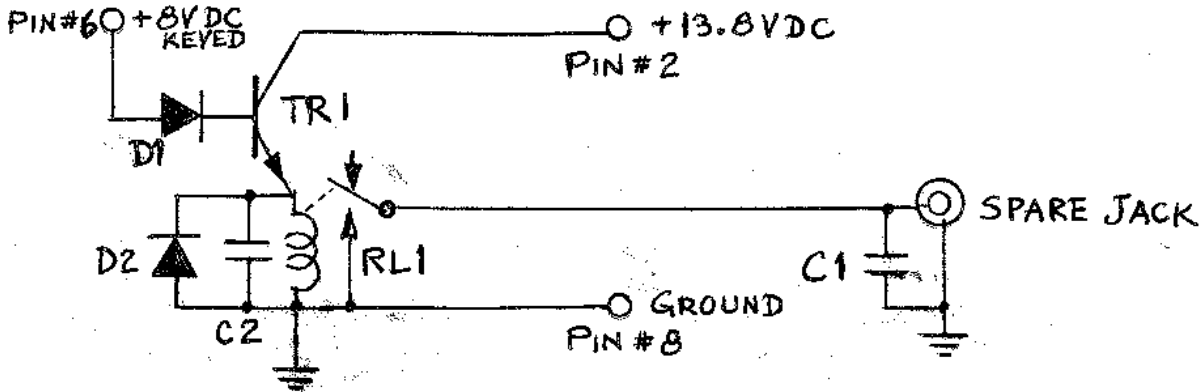

Note: D1, D2, C1, C2 are used to prevent spikes. They protect the rig and external amplifiers; don't omit them.

SOLID STATE SWITCHING

by Dave, WA3JUF

Replace the relay in your FM-21, 13-509 or other transceiver that uses a relay with this solid state DC switch.

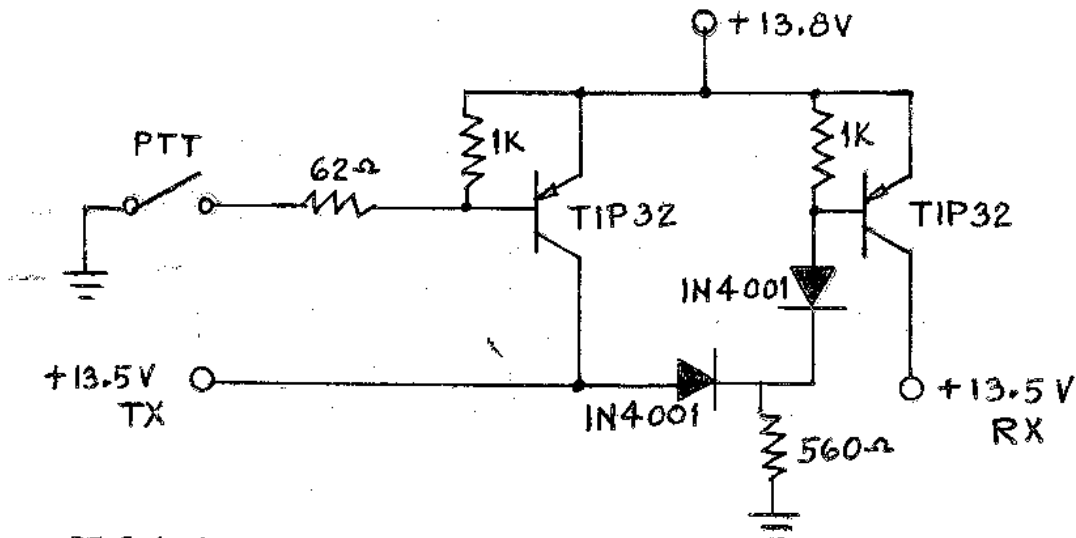

RF Switch continued on page 6.

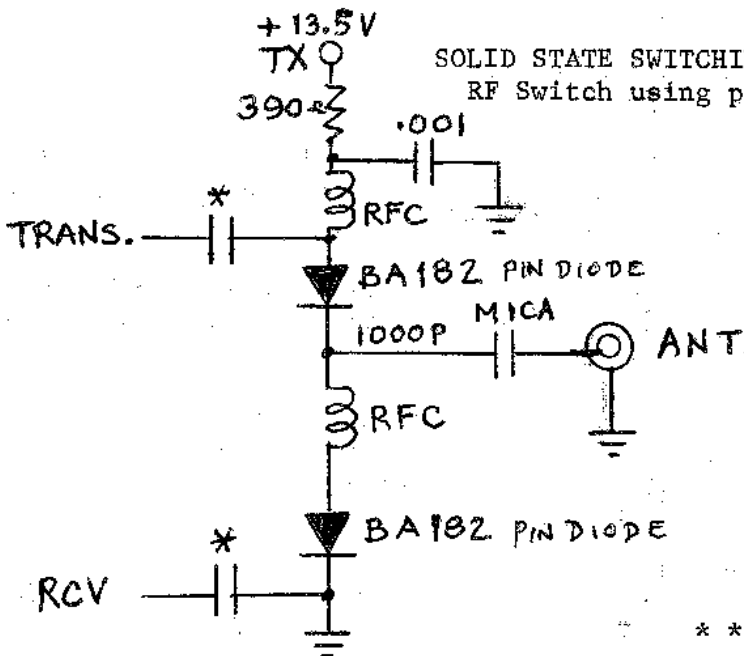

RFC- 144 MHZ = 10t, #24, 1/8in.dia.
220 MHZ = 8t, #24, 1/8in.dia.

Quarter Wave Line:
144 MHZ = 16in., strip 1/4in.
220 MHZ = 9-3/4in., strip 1/4in.
Coax.

* Existing coupling in rig, used for DC blocking.

* * * *

LUBRICATION FOR CRANK-UP TOWERS
by Steve, WA3WAS

After an extended period of time, the working mechanisms of your tower tend to become corroded. I have found that a liberal coaying of a good grade of motorcycle chain lube protects and lubricates the winch, pulleys and cables. This lubricant seems to resist extreme weather conditions. When the tower is down, spray all moving surfaces. When you are cranking up the tower, spray the cable as it is wound onto the winch.

* * * *

A NOTE OF INTEREST

by Jack Power, W2AXU

Reference: Sky and Telescope - Nov. 1980

Beginning in January 1981, the international Wolf sunspot numbers will no longer be provided by Zurich Observatory as I have reported to Cheese-Bits in the past. The numbers will be derived by A. Koeckelenbergh of the Sunspot Index Data Center in Brussels, Belgium.

The Sunspot Index Data Center will provide the monthly provisional sunspot numbers, predictions of monthly smoothed sunspot numbers and the annual international definitive Wolf numbers.

Observations from Zurich's solar station and possibly Zurich itself, will remain the basis for the Sunspot Index Data Centers' number in order to maintain continuity.

(Zurich Smoothed Number for February 1980 is 163. Monthly Number for October 1980 is 162.9)

* * * *

ARRL BULLETIN NR 116 FROM ARRL HEADQUARTERS NEWINGTON CT NOVEMBER 11, 1980
TO ALL RADIO AMATEURS BT

Freedom for amateurs to experiment with digital modes on all bands above 50 MHz has been requested by the American Radio Relay League, Inc. The petition was made public November 10, 1980 by the Federal Communications Commission which assigned the file number RM 3788 to the paper. FCC rules provide an automatic period of 30 days during which any interested party has the right to comment; the rules call for a copy of such comments to be sent to the petitioner, ARRL, Newington, CT 06111. Copies of RM 3788 may be obtained from ARRL; a return envelope is requested AR

SWAP SHOP

FOR SALE: Kenwood TS-180 with DFC, SP-180
ker, PS-30 pwr supply, optional SSB filter.

Like new, with manuals and cartons. \$940.

CONTACT: Ed Vickner, K2SNK
21 Running Brook Road
Trenton, N.J. 08638
Phone: 609-883-5318

FOR SALE: Radio Shack printer, Model 26-
1153 with interface cables for TRS-80

(5 in. paper) \$350 firm. Linear amp,
Yaesu FL 2000B- 10 to 80 mtrs. mint \$350.

CONTACT: Sam, N3SM
625 Kingston Road
Middle River, Md. 21220
Phone: 301-391-0533

FOR SALE: Kenwood TS-520S xcvr - 160
thru 10 mtrs. 100 W. pep out. Like new
\$750. Amplifier, Henry K-2000, 2 kw pep
80 thru 10 mtrs; matches Kenwood line
\$700. Antenna - Cushcraft. A220-11 - 11 E1.
220 Mhz \$10.

CONTACT: Jack Power, W2AXU
Phone: 609-882-8811

FOR SALE: 2 (ea) 450-470 Mhz, 10DB gain
stationmaster antennas - make offer. 4 (ea)
WLHDQ 432 Mhz wood boom Yagis. - Free.

All Rohn towers and accessories.

CONTACT: Steve, WA3WAS
Phone: 215-672-6486

FOR SALE: Lafayette - Ha-460, B&W low-pass
Filter included - Mint \$100

CONTACT: Hy, WA3NDE
Phone: 215-677-7986

FOR SALE: New ARRL Handbooks \$9.

CONTACT: Gene Bond, WB2UVB
Phone: 609-234-3926

FOR SALE: Pack-Rat Club Property. BDC Rex
Rotary 4 Mimeograph machine in good working
condition - manual operate or motor drive, with
supplies. First \$15. Supreme 6 mtr. SSB
xmtrs, some with VFO's. One Supreme 6 meter
SSB rcvr - no cabinet.

CONTACT: Doc, K3GAS
Phone: 635-1078 after 1 P.M.

FOR SALE: Sears Spirit Duplicator with
supply of fluid, good working condition \$10.
Electronic parts & equipment; pwr supplies,
receivers, TV games, speakers, phono
turntables, tuners, records, tapes.

CONTACT: Doc, K3GAS
Phone: 215-635-1078 after 1 P.M.
for appointment.

CLEANING HOUSE - COME & GET IT - YOU NAME PRICE
Tubes, meters - transformers & chokes.
Some goodies.

CONTACT: Deacon, W3AJF
Phone: 215-843-1808 (day or night)

REFER TO F&C SALES CO. BUSINESS CARD
AD. STORE HOURS: THURS.&FRI. 7 P.M.
TO 10 P.M. SAT. 10 A.M. TO 5 P.M.

* * *

TID BITS CONTINUED
FROM PAGE 4

Apology to WA3YUE who was left out of the line-up for the October Conference.
John Tate, K3KTY, came off the ceiling and broke his right-hand wrist - A speedy
recovery John.

Welcome back to Greg Adams, WA3UXM who finished a four year stint with the U.S. Marines.
His new address is here this month.

E1, K3JJZ makes a last call for those desiring Pack-Rat T-shirts. To order please send
check for \$4.75 for each shirt to K3JJZ, 8533 Algon Avenue, Phila., Pa. 19152.

Gene, WB2UVB delivered the baseball hats with the Pack-Rat logo and call letters
at the November meeting.

Talked to Carl Barish, WB7TCF on the phone from way up there in Washington State - he
is doing FB and sends his best to the gang.

Rich, K3HIN had a sojourn in the hospital; home now recuperating.

Thanks to Ron Cohen, K3ZKO (Captain Video) for an FB slide lecture at our November
meeting. He was there back when the Apollo 10 was retrieved from the South Pacific. He also
touched on satellite TV reception which stirred up quite a bit of interest.

THE NITE BEFORE CHRISTMAS











'Twas the nite before Christmas and all through the shack,
The rig was turned off and the mic cord lay slack.
The antenna rotor had made its last turn,
The tubes in the linear had long ceased to burn.
I sat there relaxing and took off my specs,
Preparing to daydream of armchair DX,
When suddenly outside I heard a loud sound.
I pushed back my chair and leaped to my feet,
I dashed out the door and into the street.
The moon shone down brightly and lighted the night,
For sure, propagation for low bands was just right.
I peered toward the roof where I heard all the racket,
And there was some gink in a red fur-trimmed jacket.
I stood there perplexed, in a manner quite giddy,
Just who was this stranger - di di dah dah di di.
He looked very much like an FCC guy
Who'd come to check up on some bad TVI.
I shouted quite loudly - "OM, QRZ?
Hey, you by the chimney all dressed up in red."
I suddenly knew when I heard sleigh bells jingle,
The guy on the rooftop was jolly Kris Kringle.
He had a big sack that was full of ham gear,
Which made a big load for the prancing reindeer.
Transmitters, receivers for cabinets and racks,
Some meters and scopes and a lot of coax.
He said not a word ' cause he'd finished his work,
He picked up his sack and then turned with a jerk.
He leaped to his sleigh and he shouted with glee,
And I knew in a moment he'd be QRT.
I heard him exclaim as he flew o'er the trees,
"HAPPY CHRISTMAS TO ALL, AND TO ALL SEVEN THREES."

(Unknown Source)

* * * *

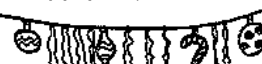
LAST MINUTE SWAP SHOP

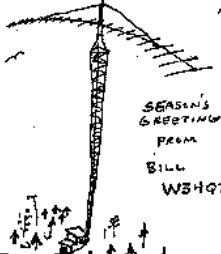
FOR SALE: Swan 500 - SSB Transceiver - \$275, Swan 117XC Power Supply & Speaker - \$75,
Swan 410 VFO - \$90. Entire package - \$400.
2 meter Pack-Rat transverter; assembled but not tested - \$50.
Supreme 6 meter SSB transmitter with 22 MHz xtal for transverter - \$25.
Crystals for Wilson/Tempo 2 meter HT - \$6 a pair.
CONTACT: Doug, WA3KES
Phone: 215-362-7909

 <p>BEST WISHES FOR '81 K3KVS JERRY</p>	<p>SEASONS GREETINGS W A 3 N D E HY - XL - FAYE</p> 	<p>Seasons Greetings Bill WA2DPU</p>	<p>Seasons Greetings de Sylvia & Harry W3CL</p> 	<p>BEST WISHES FOR THE NEW YEAR Dore & Wanda Simpson W3BKE</p>
<p>HAPPY Holiday Doe + LORETTA K3GAS 1980</p>	<p>HOLIDAY GREETINGS FLORENCE - W2AWY JACK - W2AFXU NANCY - N2D11 DAVID - W32VLA</p>	<p>SEASONS GREETINGS</p>  <p>GREETINGS</p>	<p>SEASONS GREETINGS DE ERNIE & BERT W3IKU W3TNP</p>	<p>Merry Christmas from Mike & Nancy Mindy W3BRVX</p>
<p>Merry Xmas to all and A Happy New Year 1981 Don W3CJD</p>	<p>SEASONS GREETINGS</p>  <p>Marsha, Fred & Joshua W3STEM</p>	<p>Seasons GREETINGS to SUSIE & Jo W2EIF 1980</p> 	<p>Seasons Greetings de K3UYG and The Chancellors</p>	<p>SEASONS GREETINGS FROM JOHNNIE & LORETTA W3CXU</p>
<p>SEASON'S GREETINGS from Paul Drex W3SJOY</p> 	<p>BEST OF THE HOLIDAYS from Dan & Lucy W3NFV</p> 	<p>Merry Xmas ZIMMERMAN (W3ZD) CLAN JANE MARK NAUCIE SCOTT JILL DAVE HAPPY NEW YEAR</p>	<p>Live Well - Love Much LAUGH OFTEN! MERRY XMAS "DEAC" & Lou W3AJF</p>	<p>Greeting From W3BRCF AND W3BERW</p>
<p>Happy Holidays Harry, W3IIT & Rose</p> 	<p>SEASONS GREETINGS From PAUL W3CTP</p>	<p>MERRY CHRISTMAS & HAPPY NEW YEAR LYN & SALLY LYN SR & PEARLACE</p>	<p>HAPPY HOLIDAYS W3WAS AFB1KD</p>	<p>Merry Xmas.  Pete W330VH -1980-</p>
<p>SEASONS GREETING FROM BILL W3HQT</p> 	<p>GREETINGS FROM Florida From TOM & MILDRED MATTHEWS KA4IJC</p> 	<p>Season's Greetings from Bond Amateur Radio Co. Gene W3BULB Janice K3CAX Gene W3ZMGV</p>	<p>FROM OUR HOME TO YOURS BEST Happy Holidays PEG-LEE LARRY -COHEN- K3MXX</p> 	<p>HAPPY HOLIDAYS W3AJS Low Freq Ed.</p>
<p>SEASONS GREETINGS WIL R3PHY</p>	<p>Holiday Greetings DE Gracie - W3BJA es George - W3HK</p>	<p>SEASONS GREETINGS from Helen Brick (ex W3SAO OM)</p>	<p>HAPPY HOLIDAYS JOHN & BARBARA K3KTY</p>	<p>Season's greetings from Ralph & Lynda W3FOF</p>

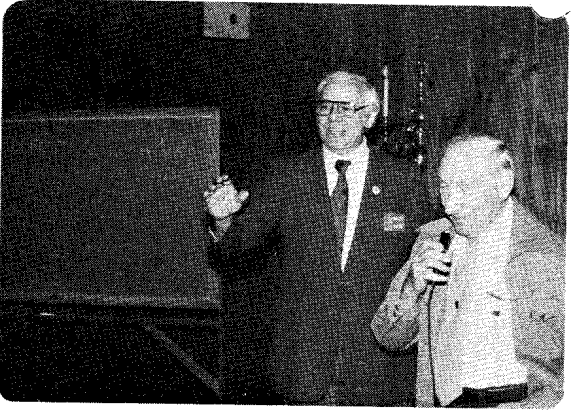
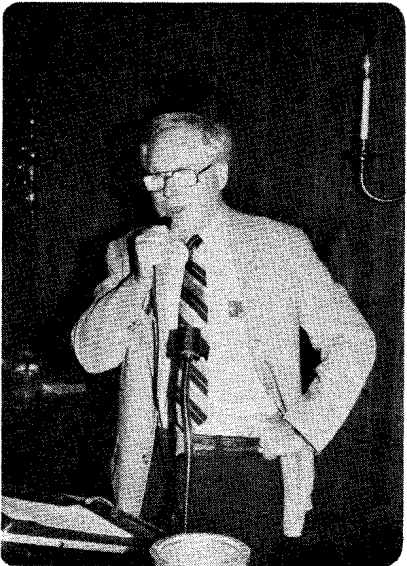
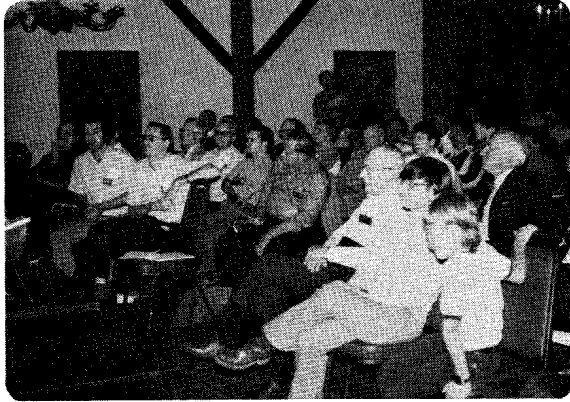
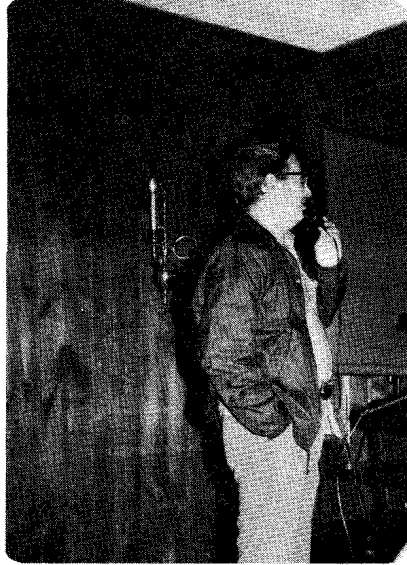
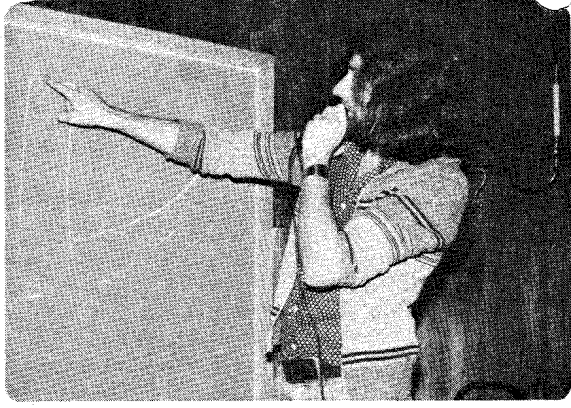
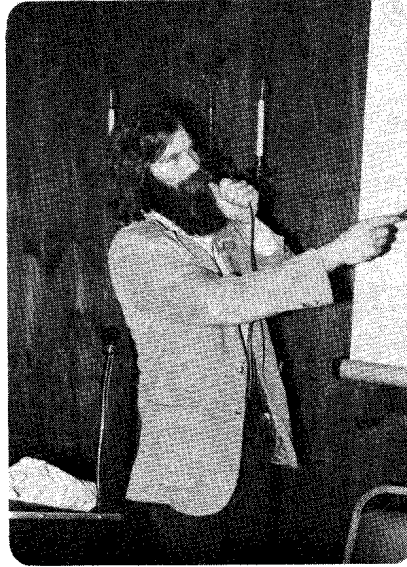
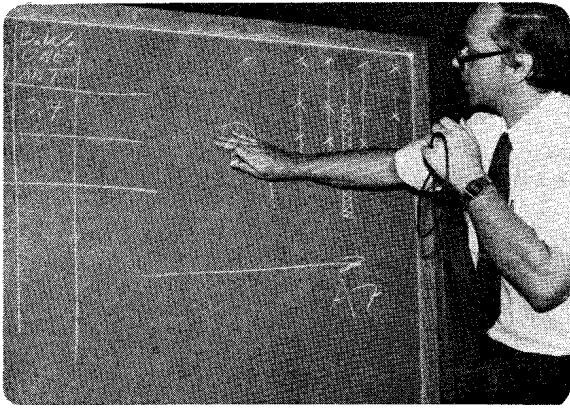

THE CONFERENCE

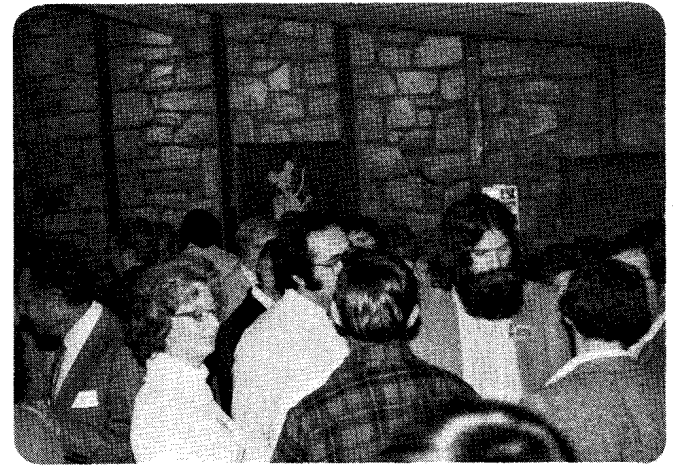
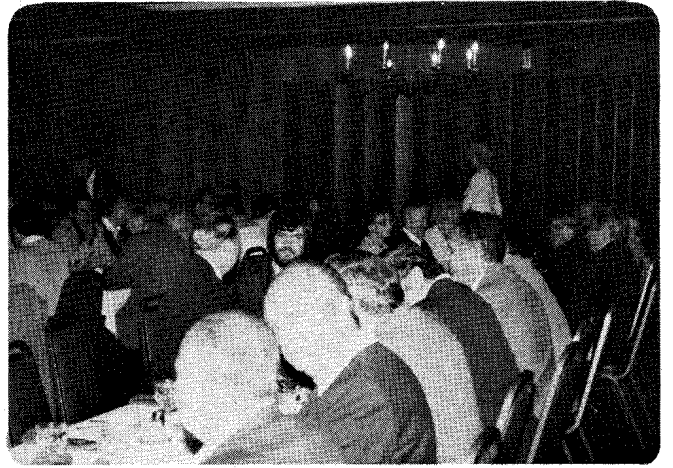

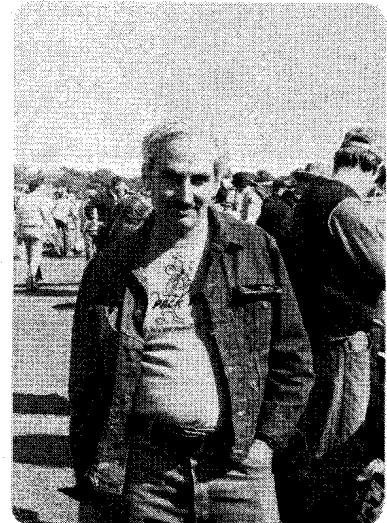
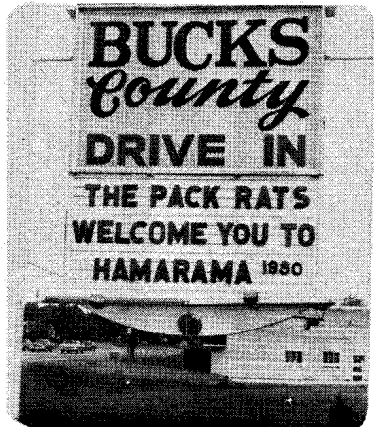
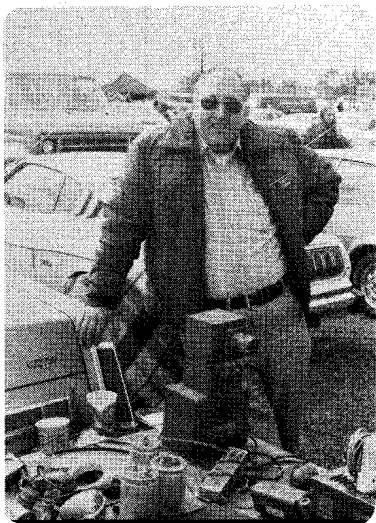
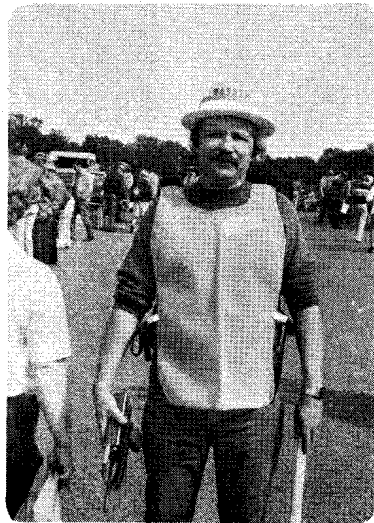
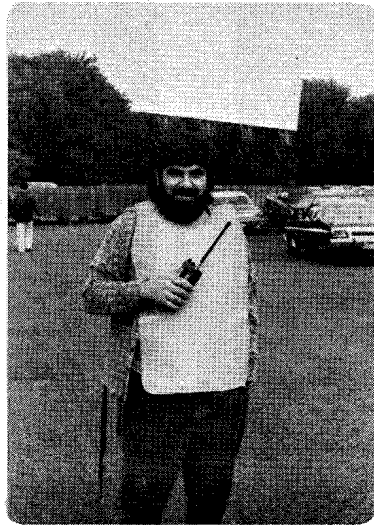
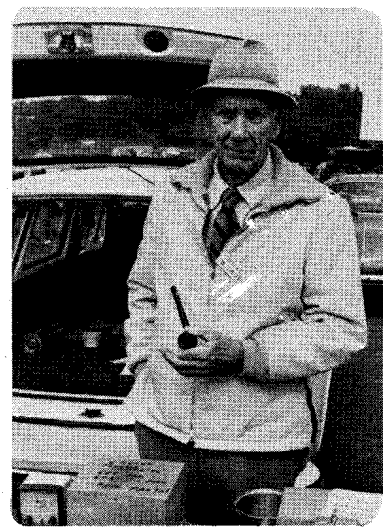
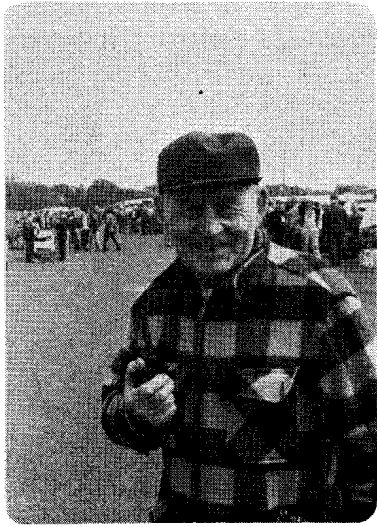

215-947-6670

MARKETLINE™

SYSTEMS, INC.

2337 Philmont Avenue
Huntingdon Valley, Pa. 19006

Computers for Hobbyists



AMERICAN RADIO RELAY LEAGUE

HARRY A. McCONAGHY, W3SW.

8708 FENWAY DRIVE - POTOMAC
BETHESDA, MARYLAND, 20034

NE 7-8329

GEORGE S. VAN DYKE, JR., P.E.
CONSULTING ENGINEER

W3HK

4607 CONVENT LANE
PHILA., PA. 19114

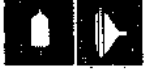

AMIL S. GUMULA
PRESIDENT

A. G. RADIO PARTS CO.
939 TOWNSHIP LINE RD.
ELKINS PARK, PENNA. 19117
TELEPHONE: 215-866-5100

RCA Authorized
Distributor

K2RPZ PRINT

stu goodman

Distinctive QSLs-Largest selection, lowest prices, top quality photo and completely customized cards. Make your own QSLs truly unique at the same cost as a standard card, and get a better return rate! Free samples, catalogue. Stamps appreciated. Stu, K2RPZ, Box 412, Dept. PR, Rocky Point, NY 11778. (516) 744-6260

AMATEUR
SALES & SERVICE

(215) OL 9-5900

"HAM" BUERGER INC.
Communication Specialists

BOB HERSHMAN
WA3ZID

68 N. YORK RD.
WILLOW GROVE, PA. 19090

(609) 546-7773

F & C SALES COMPANY
ELECTRONIC SURPLUS
TEST EQUIPMENT • COMPONENTS

BARTON BENEN

806 W. KINGS HIGHWAY
HADDON HEIGHTS, N.J. 08055

Write for FREE COPY of any of our publications.

The Ham Radio Publishing Group
GREENVILLE, NEW HAMPSHIRE 03048

Exit I-95 at Scotch Rd. South
Al & Hank (WB2GWE)



the BARGAIN BROTHERS
PHOTO & ELECTRONIC SURPLUS

CONSTANTLY CHANGING INVENTORY LOWEST PRICES

Glen Roc Shopping Center
216 Scotch Road
Trenton, N.J. 08618

(609) 883-2050

K3KTY

215-567-7130

TRANSPORT EQUIPMENT COMPANY

"EVERYTHING FOR THE TRUCK"

JOHN A. TATE
President

2215 - 2217 Race Street
Philadelphia, Pa. 19103

TV • RADIO • HAM • CB • STEREO

RICHARD H. PIERCE
ELECTRONIC EQUIPMENT REPAIR

K3MWV
(215) 785-0058

2700 NEW FALLS ROAD
NEWPORTVILLE, PA. 19056

BROWSING - THURS. 7⁰⁰ - 9⁰⁰
SAT. 9⁰⁰ - 4⁰⁰

Day-Nite (215) 455-2121

FERTIK'S ELECTRONICS

Components & Equipment

LEON FERTIK

5400 ELLA STREET
PHILADELPHIA, PA. 19120

CAR STEREO - CITIZENS BAND - BURGLAR ALARMS
2 WAY RADIO - TOWER INSTALLATION & REMOVAL
TV - HAM - CB ANTENNAS

Steve Simons

MOBILE EQUIPMENT INSTALLATIONS
SALES & SERVICE

WA3WAS

TEL. (215) RA 5-1135

8506 KENDRICK PL.
PHILA., PA 19115

215-276-4185

WA3FOF

RALPH ALEXANDER

Electronic Equipment Repair
Technical Writing
Printing

(215) 723-1200
(215) 646-2511



CARR ELECTRONICS
ALL TYPES OF RADIO & ELECTRONIC EQUIPMENT

JOSEPH J. BURGESS
W3PNL

MAIN & RELIANCE
TELFORD, PA 18969

People who look for peace get it.

--Guru Maharaj Ji

For information contact:

DIVINE LIGHT MISSION (DUO)
6037 Overbrook Ave.
Phila., Pa. 19131
Office: 215-GR 7-2800

73 magazine
for radio amateurs

73 stresses the fun of ham radio.

\$18 one year \$45 three years

POB 931 • Farmingdale NY • 11737

RESIDENTIAL

COMMERCIAL

SHAVNEY' LANDSCAPING
DIVISION - SHAVCO, INC.
111 S. EASTON ROAD
GLENSIDE, PA. 19038

PETER H. SHAVNEY, WA3OVH

886-1659

Wilson Electronics Corp.

Xcelite

Service Since 1956
215-659-5900
68 N. YORK ROAD
WILLOW GROVE, PA 19090

"Right in the middle of a lot of good company!"
Electronic Equipment Distributor

"HAM" BUEGER, INC.

If we're judged by the company we keep, we should do pretty well!

COOL OF EFFICIENCY

ROHN

BEARCOF

"W2AU" HAM-KEY

Losen Antennas

"high-gain"

SANTON

ICOM

Saxton

Miller

DRAKE

CPE

nte

GILFER LMB

TPL

Weller

Waldom

callbook

MISCO

BIRD

Vector

HUSTER

MECO

SWAN

BOMAR

SPECIAL INDUSTRIES

COVER CRAFT

SPRAGUE

TELEX

CUSHCOTT

TAB BOOKS

TEN-TEC

VIBROPLEX

NRC

South River

AMPHENOL

SCOTT

Cheese Bits

2087 Parkdale Ave.
Glenside, Pa. 19038

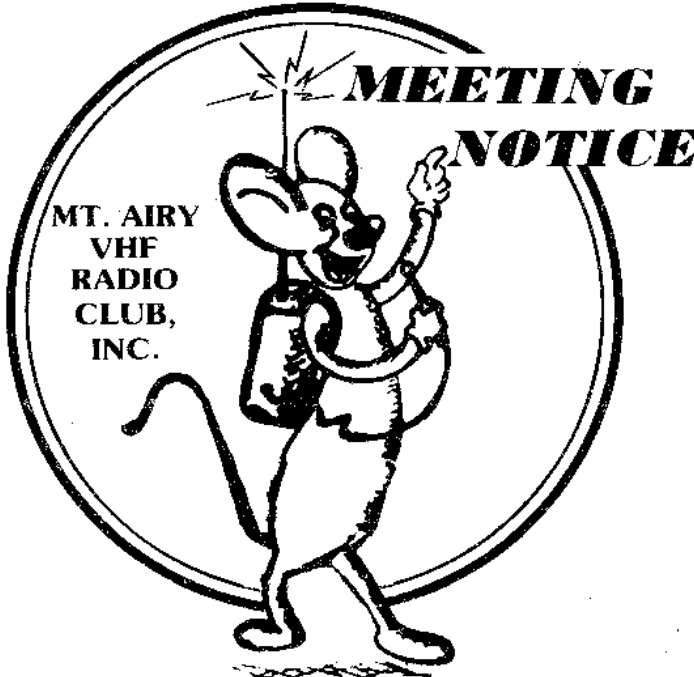
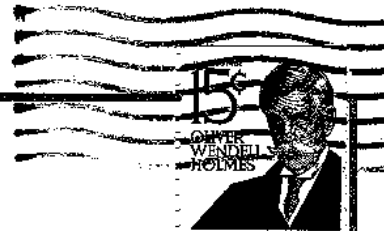

MT. AIRY
VHF
RADIO
CLUB,
INC.

WA3WAS STEVE SIMONS
435 IVY STREET
WARMINSTER, PA. 18974

PACK RATS

FIRST CLASS