

# PACK RATS'



## PACK RATS

CLUB CALL: W3CCX

MT. AIRY VHF RADIO CLUB, INC.

# CHEESE BITS



MT. AIRY VHF RADIO CLUB, INC., PHILADELPHIA, PENNSYLVANIA ARNS  
 50.125, 144.150, 220.125, 432.110, 1296.110 Mhz, W3CCX - Repeater 222.98/224.58 Mhz  
 Affiliated Club: AMERICAN RADIO RELAY LEAGUE  
 Meetings: Third Thursday of each month at 8:00 P.M.  
 Southampton Free Library, 947 E. Street Road  
 Southampton, Pennsylvania 19866

VOLUME XXVI

JUNE 1986

NUMBER 6

### THE PREZ SEZ

Now that the Sprints have passed and 'Murphy' has left the rigs, be sure to point your beams into FM08 on June 14th and 15th for the June VHF QSO Party. Working a familiar voice from back home makes the entire expedition more enjoyable.

As usual, our annual ARRL NITE was well attended. It was once again our pleasure to have Hugh Turnbull, W3ABC the Atlantic Division Director join us that evening. Our guest speaker representing the ARRL VHF/UHF Ad Hoc Committee was Bob Bennett, W3WCQ who presented a wide spectrum of information as seen through the eyes of the VUCC.

The June meeting on the 19th will bring the election of new club officers. If there is someone you would like to see in office, there is still time for last minute nominations. See page 4 for the slate of nominees at this time.

Congratulations to all as the official results have been released for the January 1986 VHF Sweepstakes, and the Pack is still numero uno - we made gavel number 26!

I'd like to take this opportunity to thank everyone for your support throughout my term in office. I'd also like to thank the Board for a job well done. Best of luck to the newly elected officers.

73,

Mike , WB2RVX

\* \* \*

### IN MEMORIUM

Lee A. Cohen, K3MXM, became a Silent Key April 25, 1986. Condolences to his family. Lee was a member of the Club for over twenty years serving as President and Hamarama Chairman. He will be sorely missed. May his soul rest in peace.

Pack Rats XHEESE BITS is a publication of THE MT. AIRY VHF RADIO CLUB, INC. Philadelphia, Pa. and is published monthly.

SUBSCRIPTION RATE - \$3.00 PER YEAR

We operate on an exchange basis with other publications. Anything that is printed in CHEESE BITS may be reprinted, unless otherwise stated, provided that proper credit is given.

SWAP SHOP ITEMS - NO CHARGE

DEADLINE FOR ARTICLES IS THE GENERAL MEMBERSHIP MEETING: THE THIRD THURSDAY OF THE MONTH.

EDITOR:

W3CL, HARRY B. STEIN  
2087 Parkdale Avenue  
Glenside, Pa. 19038  
215-887-5052

PUBLISHER/SUBSCRIPTION MANAGER:

K3GAS, DOC CUTLER  
7815 New Second Street  
Elkins Park, Pa. 19117  
215-635-1078

PRINTER:

WB2VLA, DAVID POWER  
609-882-1040

TYPIST:

WA3TEM, MARSHA LISSAUER

TRUSTEE OF THE CLUB CALL - W3CCX:

WA3AXV, RONALD WHITSEL  
215-355-5730

AWARDS CHAIRMAN:

W2EIF, JOSEPH KILGORE  
609-783-9478

CLUB HISTORIAN:

W3CL, HARRY B. STEIN

MONDAY NIGHT NETS

7:30 PM - 50.125 MHZ  
8:00 PM - 144.150 MHZ  
8:30 PM - 222.98/224.58 MHZ  
8:45 PM - 220.125 MHZ  
9:00 PM - 432.110 MHZ  
9:30 PM - 1296.1 MHZ

NET CONTROL

W3CL  
W2EIF  
K3GAS  
KS2T  
K3IUV/K1PXE  
- - -

PACK RAT REPEATER 222.98/224.58 MHZ/ W3CCX  
LOCATED IN CHURCHVILLE, PA.

OFFICERS: 1985-1986

PRESIDENT: WB2RVX, MIKE GULLO  
VICE-PRES: WA2OMY, GARY HITCHNER  
COR. SECY : W3CXU, JOHN ALLEN  
REC. SECY : W3NSI, LYN ROWLAND  
TREASURER: K3GAS, DOC CUTLER  
DIRECTORS: WB2VLA, DAVE POWER (EX-OF)  
N3CX, DAVE HACKFORD (2 Yrs)  
WA3JUF, DAVE MASCARO (2 Yrs)  
WA3AAJ, JIM WARD (1 Yr)  
WB3IND, GEORGE McMAHON (1 Yr)



THE AMERICAN RADIO RELAY LEAGUE

QST

HUGH A. TURNBULL, W3ABC  
Director, Atlantic Division

6903 RHODE ISLAND AVE.  
COLLEGE PARK, MD. 20740

(301) 927-1797

1-302-478-2757

AMATEUR  
and  
ADVANCED  
COMMUNICATIONS



G. B. WALLS

3208 CONCORD PIKE (RT. 202)  
WILMINGTON, DEL. 19803



Pennsylvania Institute  
of Technology

PAUL D. MERCADO

Chairperson, Drafting Design Department

(215) 565-7900

Rose Valley-Notre Dame Campus  
800 Manchester Ave., Media, Pa. 19063-4098

FOR SERVICE CALL  
(215) 872-3800  
(215) 872-3800



MICHAEL McMACKIN

REGISTERED PLUMBING & HEATING  
BATHROOM INSTALLATIONS • ELECTRIC DRAIN CLEANING

1307 MILL CREEK PARK  
LINDSEY, PA. 18032

2405 PARKSIDE AVE  
HATBORO, PA. 19040

CALENDAR OF COMING EVENTS  
By Harry Brown, W3IIT

JUNE

- 6 Predicted peak of the Arieted meteor shower at 0100 UTC
- 7 K3MXM - Estate Garage Sale - 9 AM at 8242 Brookside Ave., Elkins Park, Pa.
- 8 MARC Hamfest, Milton, Pa. 8 AM - 4 PM Winfield Fireman's Fairgrounds, 4 mi. S. of Lewisburg. Talk-in on 146.37/97, 146.025/.625.
- 8 Delaware Co. Amateur Radio Assn Hamfest, Drexel Hill Middle School, Drexel Hill, Pa. 8 AM doors open, license exams at 10 AM, Talk-in on 147.96/36, 224.5 and 146.52. Call 215-535-1616, 147.36 repeater.
- 8 Warminster Amateur Radio Hamfest, Middletown Grange Fairgrounds, Wrightstown, Pa. Call 215-674-8567. Talk-in on 147.36 repeater.
- 9 Brithday of Peter the Great.
- 14-15 June VHF QSO Party, Work W3CCX/8 on Spruce Knob, W. Va. See May QST, Pg. 88 for Contest Rules.
- 12 Board of Directors Meeting - QTH of WB2RVX, Mike Gullo, 22 Tenby Chase Drive, Voorhees, N.J. Phone: 609-768-4789.
- 15 Frederick Amateur Radio Club Hamfest at the Frederick Fairgrounds, 8 AM - 4 PM.
- 15 Predicted peak of the Lyrids meteor shower at 2100 UTC
- 16-21 Amateur Radio Week in Pennsylvania
- 19 General Club Meeting - Southampton Free Library, Election of Officers. Other program will be announced on the Monday Nite Nets. Marios Raffle, Frankies Silent Auction, Refreshments, Visitors Welcome.
- 21 Mean date +/-1 month of sporadic E propagation. Check 6M for short skip and move to 2M.
- 25 Custer's Last Stand 1876.
- 28-29 Field Day, See May QST, Page 79 for Contest Rules.

\* \* \*

PACK-RAT ON A CABLE TELEVISION ADVISORY BOARD

Rich Prim, WA3IWT has been elected as one of five members of the Northampton, Pa. cable television advisory board. This is a two year non-pay appointment. Rich is associated with television station KYW, Channel Three in Phila. in a technical position.

\* \* \*

VISITORS - MAY 15, 1986 MEETING

KC3LM - Kay Craigie, Devon, Pa.	W3BWQ - Sam Santoro, Blue Bell, Pa.
KC3TI - Bob Pegritz, Newark, DE.	W3WCQ - Bob Bennett, Towson, MD.
K3BRS - Al Whiting, Lanham, MD.	W3ABC - Hugh Turnbull, College Park, MD.
N3EXA - Brian Taylor, Doylestown, Pa.	W3AJS - Charles E. Keener (Ed), Oreland, Pa.
W3ICC - Drex, Wycombe, Pa.	WB3JHX - Mike McLaughlin, Phila., Pa.

NEW PRODUCTS OF INTEREST TO HAMPS

By Lyn, W3NSI

1. TELEX/HY-GAIN OSCAR ANTENNA: The #2188 OSCAR antenna is composed of a 146 Mhz 16 element (8 vert. 8 hor.) beam on a 14' boom, a 30 element (15 vert. 15 hor.) 435 Mhz beam on a 10' boom, and a fiberglass cross boom. Gain specifications are 11.5 and 14 DBD. Feedpoints are encapsulated and weather protected. The insulated crossboom eliminates interaction problems found with metal booms. Both antennas are polarity switchable using RF relays rated at 200 watts.
2. SCANNER AMPLIFIER SA-1: Hamtronics now has a combo pre-amp and tunable filter covering the range 60-250 Mhz. The notch filter covers the 60-250 Mhz range in three bands. The broadband preamp features a gain control and max gain varies from 20 db at 100 Mhz to 8 db at 800 Mhz. Amplifier operates from 12 VDC. Price \$79.
3. REMOTE COAX SWITCHES: Ameritron Co. has two antenna switch boxes designed to be mounted at a point remote from the operating position. One coax lead can then be run to the station. The RCS-4 is a four position switch for use in the 1.8-30 Mhz range, with a max power of 2500 watts. RCS 8V is a five position control box rated at 5000 watts below 30 Mhz and 1000 watts at 150 Mhz. SWR is less than 1.2/1 below 250 Mhz. This unit operates on 120 Vac. The smaller unit uses a low voltage fed thru the coax lead.
4. BUTANE POWERED SOLDERING IRON: The Amtech Co. has a pocket size soldering iron that operates on butane. Power is adjustable from 10-60 watts and the Portasol TM will run an hour on one refill. Unit is 7" long and looks like a felt tip marker. Price \$30.

\* \* \*

PHONE NUMBER CHANGE

N3BBI - Mike Pandolfo, of Jim Thorpe, Pa.  
717-325-3580 - Home  
215-767-5891 - Work

\* \* \*

NOMINATION OF OFFICERS ON MAY 15, 1986

President - WA2OMY - Gary Hitchner  
V. President - N2SB - Bob Cook  
Cor. Secretary - W3CXU - John Allen  
Rec. Secretary - WA3AQA - Walt Zumbach  
Treasurer - K3GAS - Doc Cutler

Directors for a Two Year Term:

WB3DNI - Pat Cawthorne                      WB2RVX - Mike Gullo (Ex-Officio)  
WB2VLA - Dave Power

The following directors continue serving for one more year:

N3CX - Dave Hackford                      WA3JUF - Dave Mascaro

No additional nominations were made from the floor, however, nominations remain open until the election at the June meeting on June 19, 1986.

\* \* \*

Sunspot No. for April 1986 = 20.4 - Smoothed No. for October 1985 = 17.4

APRIL VHF/UHF ACTIVITY  
By Rick Conner, WB2NPE

The 1986 Tropo season shot off with a bang on Tuesday evening April 1. Packrats and others in the Delaware Valley were treated to an intense coastal tropo duct set up from S. Carolina to Nova Scotia. 2 meters sounded like Jan. VHF SS with stations crammed from one end of the band to the other. Stations along the Virginia and N. Carolina coasts pounded overloading signals into our area. Bernie, VE1UT provided FN-63 and Canada to many area stations who had not previously worked north of Connecticut. W3HQT and others in Northern New England had signals up to 30 over 9 for several hours. 135cm and 70cm bands were equally influenced by the enhancement and VE1UT was busy with a big signal on both frequencies. Many east coast stations equipped with Oscar systems made their longest terrestrial hauls ever on 432. Toward the early morning hours, conditions held up and those equipped moved to 23cm to find excellent conditions there. We heard great signals out of WLRIL, AF1T, VE1UT, and managed to finally work W3HQT - first on CW then SSB. Other Rats heard on the bands - WA3JUF, WA3NUF, WB3JYO, W2EIF.

On April 15, KA2JMM and WA2INP from SNJ journeyed to rare grid FN-13 S. Carolina to provide a new one for many 6 and 2 operators. The trip was a success and they plan to return in early June with higher power and antennas and 432.

The Lyrids meteor shower is listed in VHF manuals as a minor shower for communications and has been written off by many "Ping Jockeys" as a waste of time. I've been looking to work Mississippi and Minnesota for 2 meter WAS and decided to make skeds with W5RCI and W0VB on 75 meters. There are always stations interested in meteors hanging out on 3818 Khz. during showers and I found both of these guys there. Worked W0VB at 0600 on the 21st and W5RCI later at 1100. Both stations were worked in under 20 minutes with several S-9, 5-second bursts. Range on each station was just under 1000 miles. You guys who like to run meteors should consider the Lyrids shower a good one as I will in the future. Always check 3818 during showers.

The 220 sprint was held on April 22. Conditions were just fair and activity was good--heard many new stations. That's encouraging! Also, QRM was at an all-time low due to 90% of the stations running CW. Compared to last year's mess of SSB splatter, this sprint was a real good time. Worked Packrats KB3QM, W2EIF, WA2OMY, WA3NUF, W3CXU, N3CX, and W3CL. Only heard one VE on the band - VE3ASO/3 in EN-94. Also, missed many of the regulars down South.

By the way, for those of you still not hooked on Grid Squares, flip on the receiver during the weak. Remember how just a couple of years ago the bands were really dead, dead, dead? Well, the bands are buzzin'. Why? Well, I guess when it comes right down to it, every one likes a little incentive and when you've already worked W.Pa. on 1296, why bother to listen West? Well, how about the other guys out there getting on the band looking for somebody out this way? This setting is precisely what's happening in places like W. Pa. and W. N.Y. And the extra incentive for us to get on is that these guys are all in different grids, slightly different headings, obstructed by a little different terrain. Sure, same as always, but a little more fun with precise aiming and pattern observations. Grids locate stations easier and better than any other practical geographical method. As a result, stations like WA3FYJ and WA3TTS both near Pittsburgh but in two different grids (FN00 and EN90) are active each night at local sunset and again at midnight on 1296 looking this way. Sure, many of us have worked Ohio on 1296, but most of us have not worked EN80 (in Ohio). Because we want EN80, NI80 has some incentive to look for us as we listen for him and improve systems at both ends. 73 es GL

VHF REPORT - by Jay Miller, KS2T

Howzabout it RATS, do do I hear 3 cheeza (cheers) for the sporadic-E season for May so far? You bet your front-end it was good! On May 6, Bob/WA1OUB in NH said that on May 5 & 6 and others up his way copied GB3SIX beacon from 2200-0100Z, also the OX3VHF beacon on 50.045. For the first several days of May the K index was on the high side from Loring, ME; 6, 7 & 8 were recorded quite often. 6 & 2 meters opened on the 10th of May with K3ACR and others working TX, AR & OK (grids EM12, 13, 34 & 35) on 2 meters just before noon EDT while 6 was open from FL to AZ. From OK, Mike/N5DDB in EM15 told me he worked NH on 2 meters and copied the Hawaiian beacon on 6 at around 1900Z. Those of you who need Hawaii take heart; its possible to get there without F2 - I've heard it once on Es. (cont'd on page 6)

CAUTION - By Jim Hoss, W4MM

Do not assemble and put up any VHF-UHF KLM beam which uses a coaxial cable balun without first checking VSWR! While this isn't to be construed as total condemnation of KLM, experience in this area with 12 of this type antenna purchased over the past 18 months, has proven in every case, that the factory furnished balun is too short. For example, the baluns furnished with 4 - 220 - 22 - LBX antennas resonated at 260 Mhz when tested in a highly reputable lab! These baluns produced a VSWR in excess of 2 to 1 when installed on the antennas. The fix, obviously, is to fabricate replacement baluns, properly dimensioned, and all will be well. Perhaps by now, KLM has corrected the problem, but, on the basis of the above, save yourself some heart and head ache - don't assume anything! Check it out before you put it up.

\* \* \*

ARRL BULLTEN NR 27 FROM ARRL HEADQUARTERS NEWINGTON CT APRIL 30, 1986:

TO ALL RADIO AMATEURS: The FCC today released the full text of its Notice of Proposed Rulemaking in PR Docket 86 161, the ARRL inspired Novice Enhancement proposal. The NPRM is based largely on the ARRL petition. The NPRM proposes new Novice privileges, as follows. CW and digital modes on 28.1 to 28.3 Mhz, CW and SSB on 28.3 to 28.5 Mhz, with Novices and Technicians only limited to 200 watts PEP output. On 220 Mhz, the entire 220 and 225 Mhz band is proposed for Novice operation, with all authorized voice and data modes permitted and a 25 watt PEP output limit. On 1240 Mhz, the segment 1246 to 1260 Mhz would be allocated to Novices, all authorized voice and data modes, with a 5 watt PEP limit. Novices would not be authorized to be control operators or station licensees of a station in repeater operation. The NPRM also contemplates expanding the Novice examination question pool to 30 questions to include questions on the operational aspects of these new privileges and also invites comments as to whether two examiners should be required to administer Novice exams. Copies of the NPRM in PR Docket 86 161 may be obtained from ARRL HQ for an SASE with two units of first class postage. The full text will appear in June QST. Comments on this proposal must be submitted to the FCC by July 16, reply comments by August 20. Comments should be submitted to the Secretary, Federal Communications Commission, Washington DC 20554. See THE ARRL LETTER and June QST for further details.

\* \* \*

A SHORT NOTE ON THE 50 MHZ SPRINT ON MAY 17, 1986

The activity on 6 meters on Saturday evening from 7 - 11 PM was fair as far as numbers participating but outstanding for all the grid squares available. Here in the local Delaware Valley grids were worked across the country in every direction except the fair Northwest. Stations were heard and worked from Canada in the Northeast to the Southern tip of the US. Pack-Rats active locally were K3ACR, N3BBI, W3CL, W2EIF, N3EAX, WB3IGR, WB3JYO, K3LOM and KS2T.

\* \* \*

JUNE VHF QSO PARTY NOTE

The Pack-Rats will be operating from EM08-Spruce Knob, W. Va. on all VHF, UHF, SHF bands with the Club call W3CCX. F.U.M.E. will be operating from EN4 (Iowa) on all the bands up to 1296 with the call W9UD. Contact Jim, W9UD on 309-799-7447 for skeds.

VHF REPORT CONTINUED from page 5

K3ACR caught K5ACR on 6, then during a lull on 6, Rich jumped down to 10 meters and worked FOX Clipperton Is.; guess that was via E also. Rich certainly has been busy. During the afternoon of May 11 Puerto Rico & the Virgins were coming through on 6. Ed/W3GUF said the KP4s were screaming for QSOs. On May 14 at 7:30 PM EDT, Ron/KB3QM worked TI2NA right out of nowhere. KP4 makes it again in the afternoon of May 18. For anyone who has propagation reports or anything else of interest concerning V/UHF, give me a call on 6. CUL es 73 - Jay, KS2T

SWAP SHOP

FOR SALE: K3MXM Estate items as follows:

Kenwood TS 520 with D104 Mic \$300.  
Drake 2B rcvr \$100; Kantronics ETU-XT  
computer interface for CW, RTTY - brand  
new \$300; 60 ft. Rohn tower w/rotor  
plus 6/2/220 ants. \$75; Lo band beam  
w/rotor \$50; 3 - 5 in. scopes.  
2 - 5 volt D.C. pwr. splys. 2 - 12  
volt D.C. pwr. splys.

CONTACT: K3GAS, Doc Cutler  
Phone: 215-635-1078

\* \* \*

COMMERCIAL ADS

FOR SALE: Lafayette HA460 6 meter transceiver, \$50; 0-30 Mhz frequency counter,  
computer Industries \$45; Drake AK-75 dipole antenna new, 160 to 10 meters \$30; Kenwood  
R-2000 General cov. receiver with CW filter \$450; Pace 23 ch. mobile CB \$30; Drake  
R4C receiver, \$195; Drake low-pass TVI filter, IKW \$30; Kenwood KPS 12, 10 amp cont. P.S.  
\$70; Kenwood TR 7850 2 meter syn. transceiver \$250; Sanyo 15" B&W monitor \$125; Sanyo  
12" Green monitor \$75. Various frequency measurement corp. test instrument at \$25. each.

CONTACT: Tony Musero, K3UKW  
1609 So. Iseminger Street  
Phila., Pa. 19148  
Phone: 215-271-8898

Loop Yagis: 902 Mhz and 1296 Mhz 45 element \$70; 2304 Mhz \$62.50. Also available  
assembled and tested. Power dividers, stacking frames available. Linear amplifiers;  
1296 Mhz. 1 watt in 18 watts out \$230; 2304: 1 watt in, 10 watts out \$300. Write for  
more information to: Down East Microwave, Bill Olson, W3HQT, Box 1655A, RFD 1, Burnham,  
ME 04922. (207) 948-3741.

\* \* \*

WANTED  
EXPERIENCED R F TECHNICIANS

American Electronic Labs, Inc. is a well known and highly respected designer and  
manufacturer of advanced electronic components and systems for DoD applications. Continued  
growth and expansion has created openings for highly experienced RF bench technicians. The  
position requires a minimum of 3 to 10 years experience in the fabrication and testing of  
High Power, Wideband solid state amplifiers operating in the 1MHz to 1GHz frequency range.  
Other RF technician positions also available. We offer an excellent salary, a full range of  
benefits and the potential for growth with a dynamic high-tech firm. If interested, please  
forward a copy of your resume to: Patricia M. Lydon, Employment Representative,  
American Electronic Laboratories, Inc., 305 Richardson Rd., Lansdale, Pa. 19446

\* \* \*

TID BITS

K1FO, Steve reports that the Eastern VHF, UHF, SHF Conference was a FB affair.  
The K2RIW tower case which was appealed has been postponed-might be a good sign.  
The Upper Dublin Township Montgomery County, Pa. tower and dish ordinance has been  
nipped in the bud thanks to involvement by the local hams. (W3AJS, KB3JW & W3EAG).  
KC3LM, Kay Craige the E. Pa. ASM was visitor at our ARRL Nite meeting. She is running  
for E. Pa. SM and we wish her good luck.  
K3BRS, Al Whiting on his way to Lanham, MD from the Eastern Conference in NH report he  
enjoyed the fine event very much. Nice to see you again Al.



HUGH TURNBULL, W3ABC  
DIRECTOR, ATLANTIC DIVISION

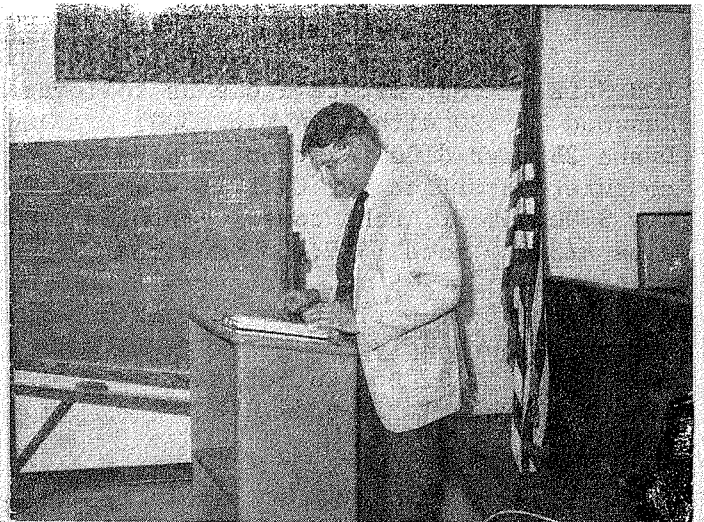

BOB BENNETT, W3WCQ  
VUCC, VHF COMMITTEE

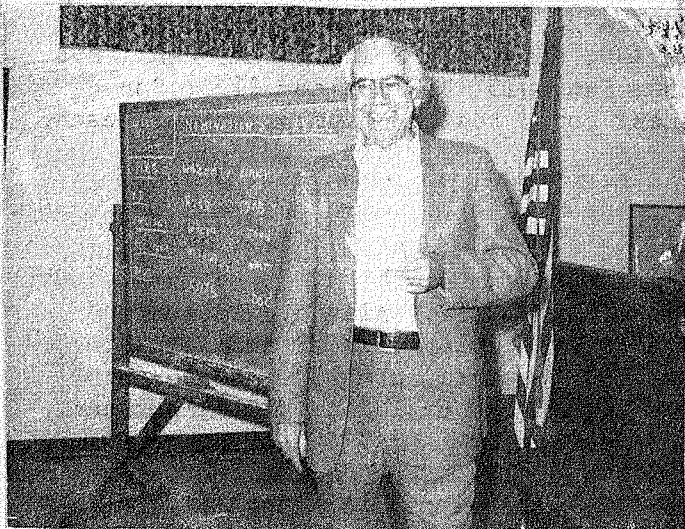

DAVE ZIMMERMAN, W3ZD CONDUCTS  
THE NOMINATIONS

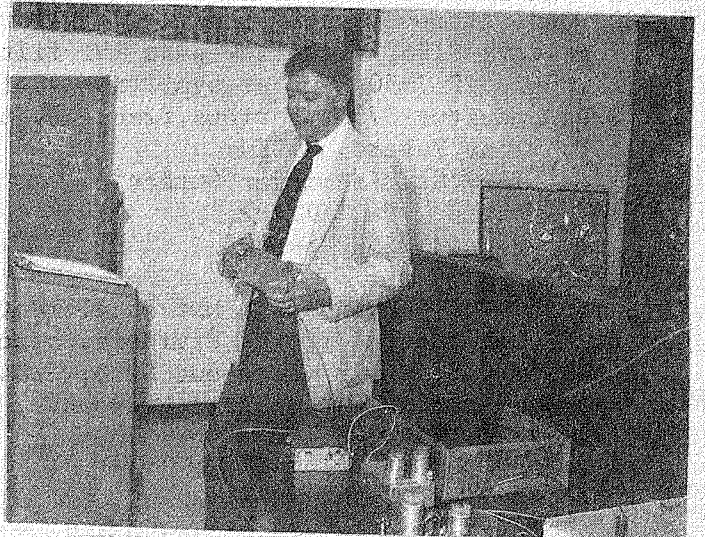

W3WCQ DESCRIBES A 2.3 GHz REPEATER  
CONTROL SYSTEM



KAY CRAIGE, KC3LM THE E.P.A ASSISTANT  
SECTION MANAGER

# ARRL NIGHT — 1986



## 1 Watt Class 'A' Linear Amplifier for 2.3 GHz.

Vce 22v

Icq 220 ma.

Pg > 7 DB at 1 db compression

Pout > 1.0 Watt @ 1 db comp.

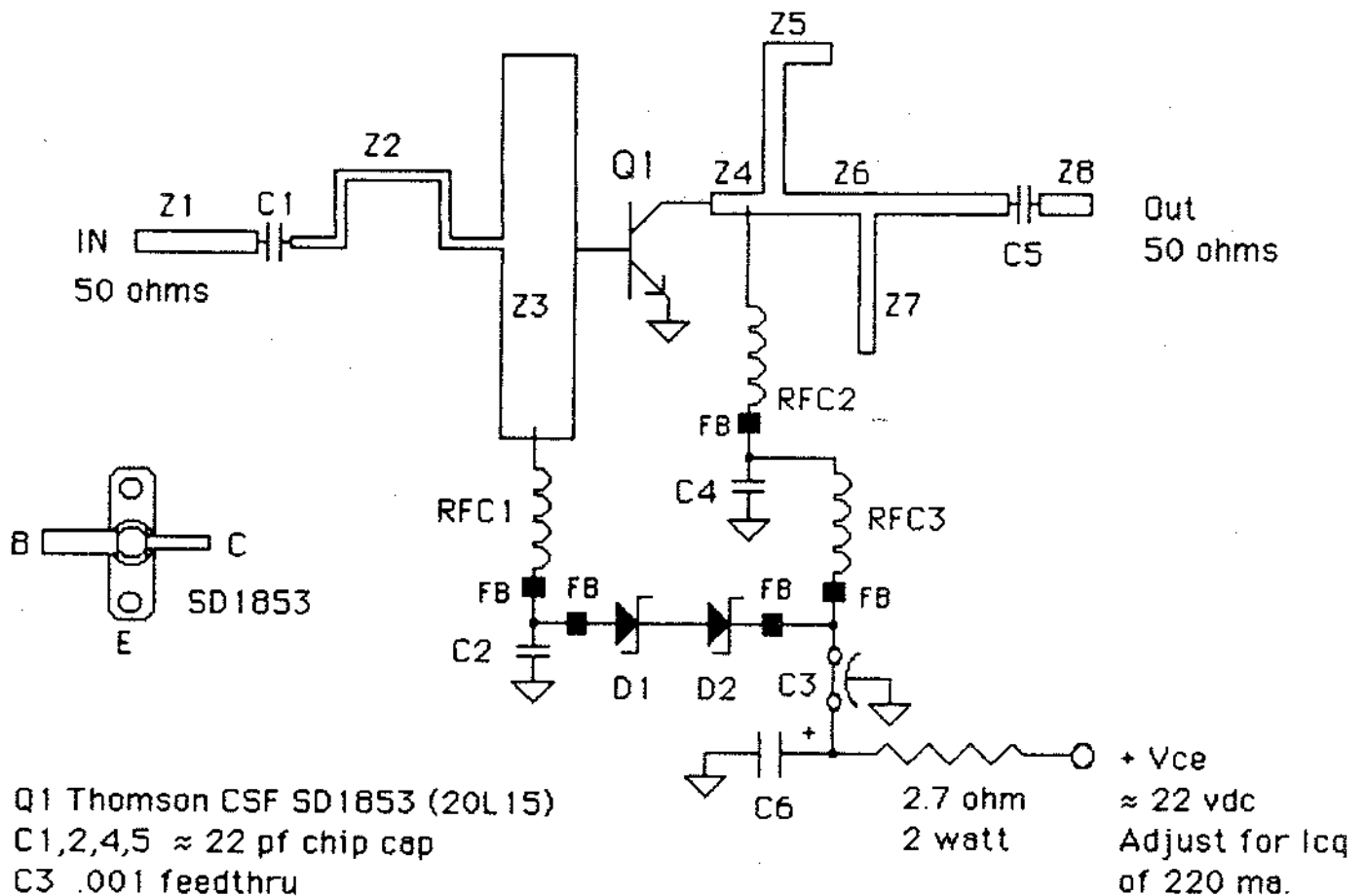

Q1 Thomson CSF SD1853 (20L15)

C1,2,4,5 ≈ 22 pf chip cap

C3 .001 feedthru

C6 10 ufd/25 vdc

RFC1,2 3t, #28, 0.1" ID

RFC3 8t, #26, 0.15" ID

FB ferrite bead

D1 9 volt zener (1N4739A)

D2 12 volt zener (1N4742A)

Z1,8 50 ohm microstrip 0.080" wide

Z2, thru Z7 microstrip (see artwork)

Board material is 1/32" Teflon Er = 2.5

W3HQT 1984

Drawn by WA3JUF 1985

Amplifier is tuned by bridging microstrip pads with solder, or trimming with an Exacto knife.

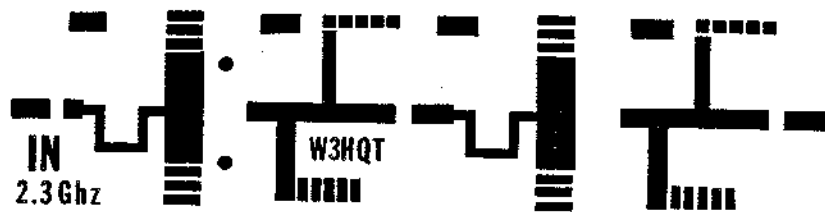
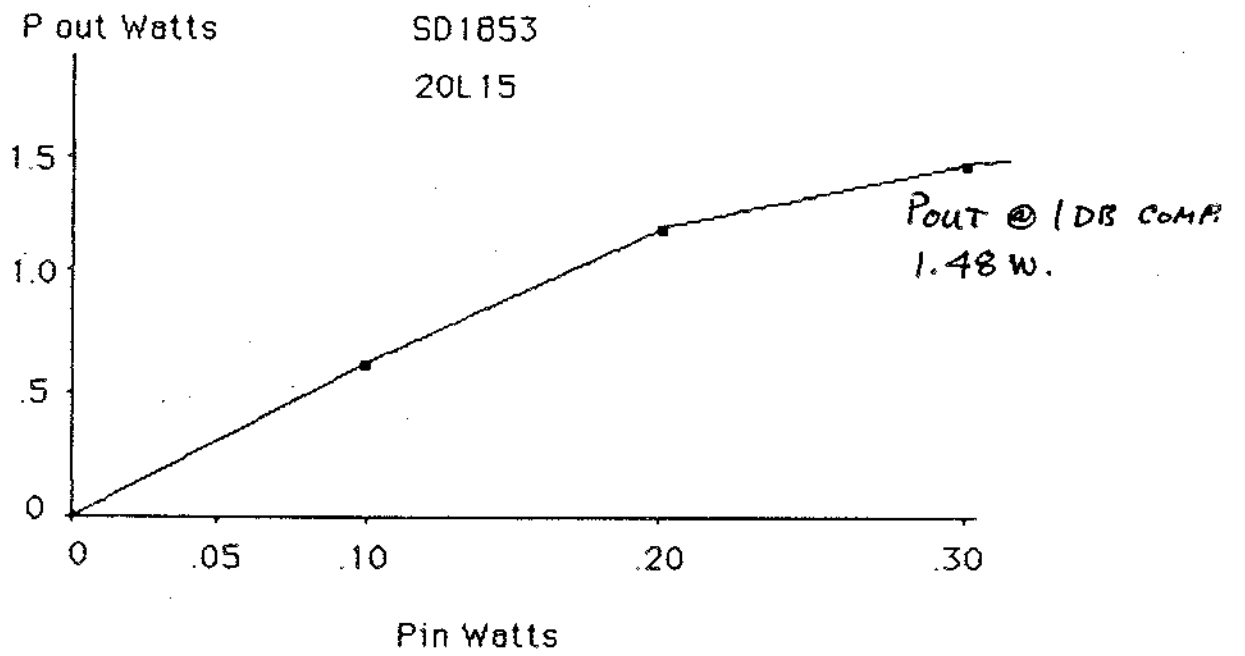

## DOWN EAST MICROWAVE

BOX 1655A - RFD #1  
BURNHAM, ME 04922

Microwave Antennas and Amplifiers  
by W3HQT

902 1296 2304 3456 MHz.

Bill Olson (207) 948-3741

## 73 Amateur Radio's Technical Journal

PO BOX 931  
FARMINGDALE, NY 11737

\$25 one year \$53 three years

NE 7-8888

GEORGE S. VAN DYKE, JR., P.E.  
CONSULTING ENGINEER

W3HK

4607 CONVENT LANE  
PHILA., PA. 19114



AMIL S. GUMULA  
PRESIDENT

A. G. RADIO PARTS CO.  
399 TOWNSHIP LINE RD.  
ELKINS PARK, PENNA. 19117  
TELEPHONE: 215-886-5100

**RCA** Authorized  
Distributor

(302) 328-7728  
ORDER LINE 800-441-7008



*Delaware Amateur Supply*  
"AMATEUR SALES AND SERVICE"

PAUL WA3QPX  
KATHY KA31Y0

71 MEADOW ROAD  
NEW CASTLE, DELAWARE 19720

AMATEUR  
SALES & SERVICE

(215) OL 9-5900

**"HAM" BUERGER INC.**  
Communication Specialists

BOB HERSHMAN  
WA3ZID

68 N. YORK RD.  
WILLOW GROVE, PA. 19090

215-342-5982

WA3HIT

Paul and Betty Rilling

INCOME DIVERSIFICATION

5830 Weymouth Street -Phila., Pa.19120

## The Ham Radio Publishing Group



Greenville, NH 03048 (603) 878-1441

HAM RADIO - the Technical Ham's  
Magazine. Ask for a free sample  
copy or our Book Catalog.

CALL DOC CUTLER (K3GAS)  
FOR YOUR ELECTRONIC NEEDS

NRW, RECONDITIONED, OR AS IS.

LOW PRICES

by appointment

215-635-1078

CARL BARISH

**PRINTECH** 13620 NE 20th Suite D  
**PRINTING** Box 4247  
Bellevue, WA 98009  
746-8000



**NESHAMINY  
TRAVEL  
SERVICE**

Harriet Soltoff  
Home: (215) 947-4483

xy1 K3IUV

2337 Neshaminy Blvd.  
Bensalem, PA 19020

BROWSING - THURS. 7<sup>00</sup> - 8<sup>00</sup>  
SAT. 9<sup>00</sup> - 4<sup>00</sup>

Day-Nite (215) 455-2121

**FERTIK'S ELECTRONICS . . . . .**

*Components & Equipment*

LEON FERTIK

5400 ELLA STREET  
PHILADELPHIA, PA. 19120

LUNAR, MICROWAVE MODULES, ARCOS, ASTRON, KLM  
TAMA, TONNA F9FT

THE  
**VHF SHOP**

TOM KQ3R  
16 South Mt. Boulevard  
Mountaintop, Pa. 18707

(717) 474-9399  
M - F after 6:00 p.m.  
Weekends Anytime!

## EASTSIDE SURPLUS SALES

12894 NE 15th PLACE  
BELLEVUE, WA 98005

(206) 453-0795

Carl Barish  
KC7ZC

A CANDY STORE OF PARTS FOR THE EXPERIMENTER.

(302) 328-7728  
ORDER LINE 800-441-7008



*Delaware Amateur Supply*  
"AMATEUR SALES AND SERVICE"

ROB WA3QLS  
GAIL KA3ITN

71 MEADOW ROAD  
NEW CASTLE, DELAWARE 19720



## Jenkintown & Glenside Electric Co.

WA3WLQ

220 YORK ROAD  
JENKINTOWN, PA.  
TUmer 4-0375 - 4-1050  
WA 7-4325

**"HAM" BUEGER, INC.**  
 Electronic Equipment Distributor  
 "Right in the middle of a lot of good company!"  
 68 N. YORK ROAD  
 WILLOW GROVE, PA 19090  
 215-659-5900  
 Service Since 1956

If we're judged by the company we keep, we should do pretty well!  

**PACK RATS**

**FIRST CLASS**

The advertisement is surrounded by a dense border of logos for various electronic and radio-related companies, including:
 

- Wilson Electronics Corp.
- Xcelite
- Sprague
- TELEX
- Cushcraft
- AMPHENOL
- TRW
- TEN-TEC
- TRW TAB BOOKS
- VIBROPLEX
- BEARCAT
- "W2AU" HAM-KEY
- Larsen Antennas
- ASTATIC
- ROHN
- South River
- ICOM
- GE
- Saxton
- Drake
- Midex
- Waldom
- Weller
- TPC
- GILFER LMB
- callbook
- Waldom
- Milly
- communications specialists
- MISCO
- BIRD
- Vector
- HUSTER
- phelps dodge
- AMSCO
- BOMAR
- AMP SPECIAL INDUSTRIES
- COVER CRAFT
- SWAN
- TELETYPE
- TELETYPE

**Cheese Bits**

2087 Parkdale Ave.  
Glenside, Pa. 19038

**MEETING NOTICE**

MT. AIRY  
 VHF  
 RADIO  
 CLUB,  
 INC.



**PACK RATS**

**FIRST CLASS**