

CHEESE BITS



W3CCX

SCANNED TO PDF BY BERT, K3IUV, 2013

CLUB MEMORIAL CALL



ARRL
Affiliated
Club

VOLUME XXXIX

April 1997

Number 4

THE PREZ SEZ

Thanks to everyone that participated in last months Homebrew Night. The diverse array of projects proved once again that the art of homebrewing is alive and well in the land of Packrats. Special thanks go to our excellent panel of judges WC2K, K3GNC, and KB3PD who had the tough task of reviewing each project and interpreting the award categories to make their final selections. Congratulations to all of the award winners.

It looks like spring has finally arrived. I can tell because every time I walk by the tower I notice things I want to fix or change and can't use the weather as an excuse any longer. Spring is also a season of improving band conditions. The sunspot cycle is mercifully on the rise again so hopefully aurora and e-skip and major band openings will soon liven up all those quiet receivers. A good start is the upcoming Spring Sprints. The Sprints are a fun way to overcome the January burnout effect. The 2M sprint is usually bedlam as everyone jumps into the contest mode by force of habit. But the real fun occurs on the 220 and higher Sprints where the true weak signal operators show their stuff and everyone goes-a-hunting for DX grids aided by a little springtime enhancement. The start of Sprint season is rapidly approaching so mark your calendars and plan to spend a few hours having a great time on the air.

If the January contest is over can June be far ahead? The rumblings have begun and June contest fever is slowly starting to take hold once again. Last year the club effort included a record turnout of members and a score which nearly doubled our previous best. This was no accident. We have proven time and time again that when we ALL get behind a project there is no limit to what the members of this club can accomplish. We will shortly ask K3GNC our resident contest sage, seer, and soothsayer to set the June contest goal but in the meantime I hope you will join the effort and help plan and secure another record score for W3CCX.

This month's program is our annual ARRL Night. We are pleased to have Paul Danzer N111 from the League Technical Department visit along with Kay Craigie the Atlantic Division Director and other invited guests. With the almost daily news flashes of new assaults on our frequencies by the little LEO satellite companies and WLAN spread spectrum folks this meeting is a great opportunity to learn first hand what the League is doing to protect our bands and what help they need from all of us. I hope you'll join us for a very informative evening. See you at the meeting.

73 and CQ Sprint.
Phil WA3NUF

MEETINGS

Third Thursday each month at 8:00 PM
Southampton Free Library
947 E. Street Road
Southampton, PA 18966

Pack Rats' **CHEESE BITS** is a monthly publication of the
- Mt. AIRY VHF RADIO CLUB, INC. -

Southampton, PA

SUBSCRIPTION RATE: \$10.00 PER YEAR (USA)
\$12.00 PER YEAR (CANADA)
\$15.00 PER YEAR (ELSEWHERE)

We operate on an exchange basis with other non-commercial publications. Anything that is printed in **CHEESE BITS** may be reprinted in a not for profit publication, unless otherwise stated, provided proper credit is given.

DEADLINE FOR ARTICLES AND SWAP SHOP IS THE MONTHLY MEETING DATE. NON-COMMERCIAL SWAP SHOP ITEMS-FREE OF CHARGE.

SUBSCRIPTION/ADVERTISING MANAGER:

Bob Fischer, WB2YEH
7258 Walnut Avenue
Pennsauken, NJ 08110
(609) 665-8488

EDITOR:

Harry Brown, W3IIT
3012 Potshop Road
Norristown, PA 19403
(610) 584-4846
hbrown@vf.lmms.lmco.com
hbrown@voicenet.com

CLUB TREASURER:

Dave Mascaro, W3KM
1603 Mink Road
Ottsville, PA 18942
(215) 795-2648
dmascaro@gic.gi.com

AWARDS CHAIRMAN:

Bob Fox, W3GXB
(610) 346-8698

TRUSTEE OF CLUB CALL - W3CCX

Ron Whitsel, WA3AXV
rwhitsel@aol.com
(215) 355-5730

PACKRAT 222 MHz REPEATER - W3CCX/R

222.98/224.58 MHz, Churchville, PA FN20LE

OFFICERS: 1996-1997

PRESIDENT: WA3NUF Phil Miguelez, pmiguelez@gic.gi.com
VICE PRES: N3AOG Dick Comly, 104242.2614@compuserve.com
REC. SECR: WA3AQA Walter Zumbach
TREASURER: W3KM Dave Mascaro, dmascaro@gic.gi.com
COR. SECR: KB3XG John Sorter, JohnKB3XG@aol.com
DIRECTORS: N3DQZ Jack Kauker (2 Yrs) jkauker@voicenet.com
WA3AXV Ron Whitsel (2 Yrs) rwhitsel@aol.com
N3OZO Don Schwartzkopf (1 YR)
WB3KRW Steve Dallas (1 YR) sdallas@erols.com

MONDAY NIGHT NETS

<u>TIME</u>	<u>FREQ.</u>	<u>NET CONTROL</u>
7:30 PM	50.150 MHz	K3EOD
8:00 PM	144.150 MHz	N3ITT/AA2UK
8:30 PM	222.125 MHz	WB2YEH/N3EXA
8:30 PM	224.58R MHz	W3GXB
9:00 PM	432.110 MHz	WA3AXV
9:30 PM	1296.100 MHz	WA3NUF
10:00 PM	903.100 MHz	N3AOG

COMMITTEE CHAIRMEN

LADIES' NIGHT: N3AOG 215-443-9965
JUNE CONTEST: WA3AXV 215-355-5730
HAMARAMA: WB3JYO 609-538-1687
VHF CONFERENCE: KB3XG 610-584-2489

PACK RAT BEACONS - W3CCX/B FM29JW

432.298 MHz 903.071 MHz
1296.262 MHz 2304.034 MHz



THE AMERICAN RADIO RELAY LEAGUE

KAY C. CRAIGIE, WT3P
DIRECTOR, ATLANTIC DIVISION

5 Faggs Manor Lane
Paoli, PA 19301-1905
(610) 993-9623

wt3p@arrl.org



THE AMERICAN RADIO RELAY LEAGUE

Bernie Fuller, N3EFN
VICE DIRECTOR, ATLANTIC DIVISION

17668 Price Road
Saegertown, PA 16433
814-763-1529

n3efn@arrl.org

STEVEN N. WHITE
Attorney at Law

2217 PALOMINO DRIVE
WARRINGTON, PA 18976

TEL: (215) 343-6902
FAX: (215) 343-6903

Calendar of Coming Events - April 1997

- 5-6. Timonium Md. **ARRL Maryland State Convention and Greater Baltimore Hamboree and Computerfest** at the Maryland State Fairgrounds. VE exams given. Call 1-800-HAM-FEST. TI on 146.67- and 224.24.
- 8 **Packrat Board of Directors Meeting** at the QTH of Brian, N3EXA at 8 P.M. All interested parties invited. Call 215-257-6303 for directions.
- 12 Physicist John Thompson demonstrated his discovery of a body smaller than the atom, a negative charged he called a corpuscle now known as an electron in 1897.
- 14 **ARRL 144 MHz Spring Sprint** (Monday evening) starting at 7-11 PM local time. See April QST, page 98 for rules. Results will be published in the NCJ.
- 17 **Packrat Meeting** at the Southampton Free Library at 8:00 PM. **ARRL Night**. Bring and/or invite your on the air VHF buddies. All VHFers invited. The speaker will be Paul Danzer, N111, from the ARRL Technical Department.
- 20 The **Pen-Del Hamfest** will be held at the NUR Temple, 198 DuPont highway (Rte 13 near US40 split), Newcastle DE. Talk-in on 224.220 and 147.225+.
- 22 **Lyrids meteor shower** peaks at 0345 UTC.
- 22 **ARRL Spring 222 MHz Sprint** (Tuesday evening) 7-11 local time. See March QST, page 98 for rules.
- 22 **Passover**
- 24 **LEAP INTO THE MICROWAVES with the Packrats!** 903 and above. Starting on the 4th Thursday of the month and continuing every 4th Thursday of the month operate from 8 to 10 PM local time on any band 903 MHz and above. For coordination on those difficult long haul contacts 144.260 MHz is the suggested liaison frequency. So here's your chance to fix what broke in the contest and work all those stations you missed.
- 25 Italian engineer and inventor **Guglielmo Marconi**, inventor of the wireless telegraph and Nobel Prize winner was born in 1874.
- 26 **Cherryville Repeater Assn. Hamfest** at the Warren County Farmers Fairgrounds in Belvidere, NJ. TI on 147.375.
- 26-27 **22 ND Annual Trenton Computer Festival** at Mercer County Community College, just north of Trenton NJ. This is the longest running computerfest in the world. Several sessions on amateur radio including no-code license cram sessions and exams as well as a separate packet radio conference. VE exams all day Saturday.
- 30 **ARRL Spring 432 MHz Sprint** (Wednesday evening) 7-11 local time. See April QST, page 98 for rules.
- May 10 **Packrat Ladies Night** will be held at the Mill Race Inn, Holland in Warrington, Pa. starting at 6:30 PM.

TID BITS

The RF Hill Radio Club has VE Testing on the third Monday of the month at 6:30 PM at the Valley Public Library in Telford, Pa.

The April issue of the NTMS newsletter Feedpoint has an article by Don, N0UGY on "A Transmit/Receive Sequencer". John, K3PGP, has an article on "Building a Laser MCW, NBFM, SSB System". An article is included on a "New Renewable Power Source for Hams".

The November issue of QEX (you thought that Cheesebits got out late?) is a VHF issue. Paul, N1BWT's article is "Noise Measurement and Generation". Next, Mark, K5AM fills in the details of his "Luxury Linear" (a 1500 watt output 2M linear) from the May 96 issue of QEX with "Design Notes for "A Luxury Linear Amplifier". Both articles are must reading for anyone planning a DC Band of VHF linear amp. The last of the issue is Zach, W1VT's column "RF" giving practice details on mounting RF connectors.

The current 144-MHz standings were compiled April 1 and are available on the ARRL Web site at:

<http://www.arrl.org/announce/standings/144.html>. These standings are scheduled for publication in the "World Above 50 MHz" column, June QST. If you spot any errors or omissions, please let me know before 1600 UTC, April 10. Thanks and 73, Steve, WB8IMY, QST Managing Editor

THANKS FOR YOUR SUPPORT

Thanks, to all the members for their support during the last 6 weeks. Our club is comprised of a group that never fails to help a member that runs into difficult "times". My Dad was taken to the hospital unexpectedly one Saturday morning after Janice and I found him in bad shape. With two businesses to run and the trips to the hospital at all hours my time was just about gone. All I had to do was ask and my responsibilities for the club were assumed by others. To those folks a special thanks. Janice and myself thank the club in general for their support, flowers, and personal visits during our time of need.

Dick, N3AOG and Janice N3CFE

HORACE, W3AJF, 75 YEARS AS A HAM

W3AJF, Horace Deacon was awarded a plaque by the Quarter Century Wireless Association to honor his 75 years as a ham. First licensed in 1922, Horace was presented the award by W3HK, George Van Dyke, president of the Delaware Valley Chapter. (Present at the award were Horace's family as well as a group of QCWA members. This event took place at the Ft. Washington Estates Retirement Home where Horace can be visited. Many photos were taken and greetings exchanged and memories revisited. We salute Horace as our most senior Packrat. Send a card and wish him well. Mail to: Horace Deacon, W3AJF, % Mrs. Ann Bray, 1136 Keats Court, Lansdale, PA 19446 .(Mrs. Bray is Horace's daughter)

HOME BREW NIGHT

Another fine group of homebrew projects were shown at the Annual Homebrew Night at the March meeting. See pictures of the projects elsewhere in this issue of Cheesebits. The following presenters and projects were shown:

Steve, WB3KRW	903 MHz Transverter and the W3CCX Beacon Keyer
Phil, WA3NUF	Complete 2304 MHz Transverter
Ron, WA3AXV	3456 MHz Omni Antenna for the W3CCX Beacon Farm
Len, N3NGE	Cavity Front End 1296 MHz LNA
Dave, W3KM	Multi-Port Transverter Control Switch Box (see first part of his article in the April issue of Cheesebits and the remainder in this issue.
Henry, N3NID	Digital Degree Logger
Mark, NK8Q	Direct conversion Transmitter and Receiver

The judges selected the following winners:

Most Ambitious:	Complete 2304 MHz Transverter by Phil, WA3NUF
Best Design:	1296 MHz Preamp/Cavity Filter LNA by Len, N3NGE
Best Construction:	Multi-Port Transverter Control Switch Box by Dave, W3KM
Most Unique:	Digital Degree Logger by Henry, N3NID

CHEESEBITS SUBSCRIPTIONS

Cheesebits subscriptions are available to everyone interested in activities and information from the VHF through the microwave frequencies. Subscriptions are for 1 year of 12 issues. For a subscription, send the following information:

Name: _____ Call: _____

Street Address: _____

Town: _____ State: _____ ZIP: _____

Subscription Rate: \$10.00 per year (USA), \$12.00 (Canada), \$15.00 (Worldwide)

April 1997 Send to: SUBSCRIPTION/ADVERTISING MANAGER:

Bob Fischer, W2SJ

7258 Walnut Avenue

Pennsauken, NJ 08110

The Mt. Airy VHF Radio Club, Inc.

Southampton, Pa



Welcome to the Mt. Airy VHF Radio Club better known as the "Packrats". The Mt. Airy VHF Radio Club is dedicated to serving the VHF / UHF / Microwave Amateur radio community as well as enhancing the state of the art for 50 MHz and above operation. This year we celebrated our club's 40th anniversary.

- Latest News
- Meetings - Where And When We Meet
- The Agenda - Monthly Speakers, Sales, Events
- Club Sponsored Nets, Activity Hours And Beacons
- Technical Info - Grids, Beacons, Articles
- Club Contacts and Packrat's History
- Cheese Bits - Our Monthly Newsletter
- Links To Other Interesting Sites

Club Webmaster: Ron - WA3AXV

Web Author: Deskware Web Designs

The Mt. Airy VHF Radio Club Web Page URL is: <http://www.IJ.NET/packrats/>

PC Board Layouts

1:1 Scale

Trace Side

1/16" G-10 type material

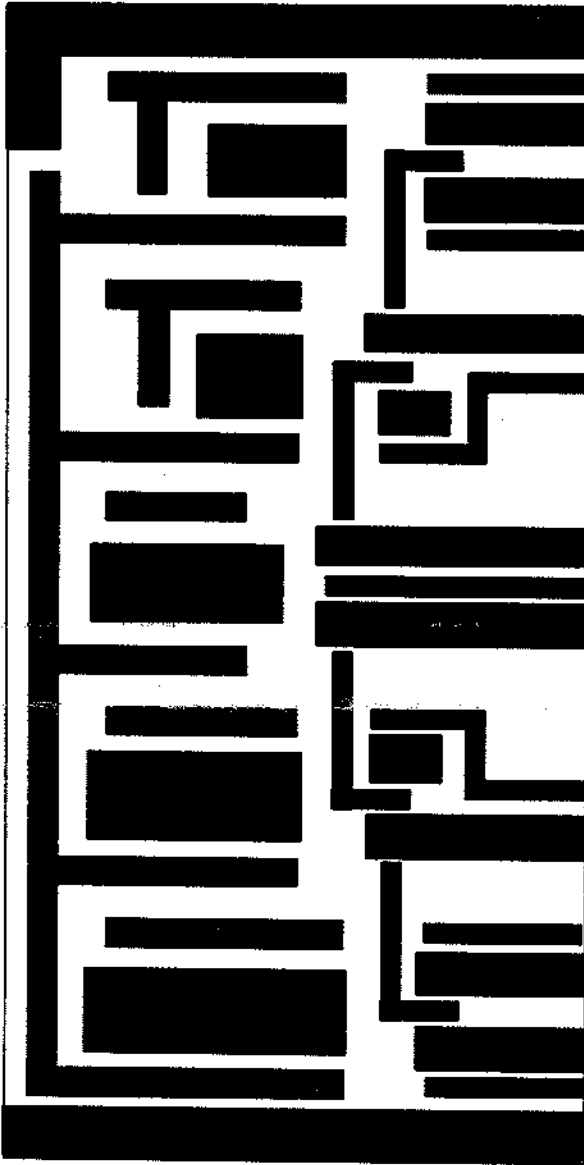



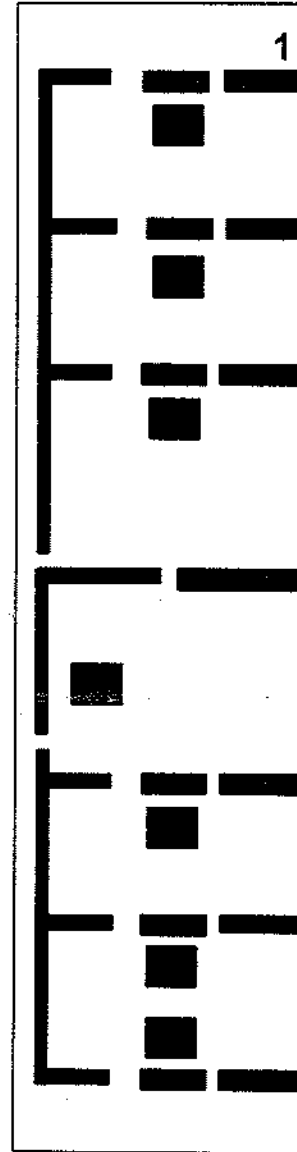

Relay type



Pin diode type

6-Position Pin Diode RF Switch

- C1  = .01 ufd chip
- L1  = 10 uh, leaded or SMD
- C2  = .001
- R1  = 47K 1/8W
- D1  = Pin diode
Unitrode UM-9401
Philips BA182
Motorola MPN3404, etc.
- R2 470 ohm 1/2 W

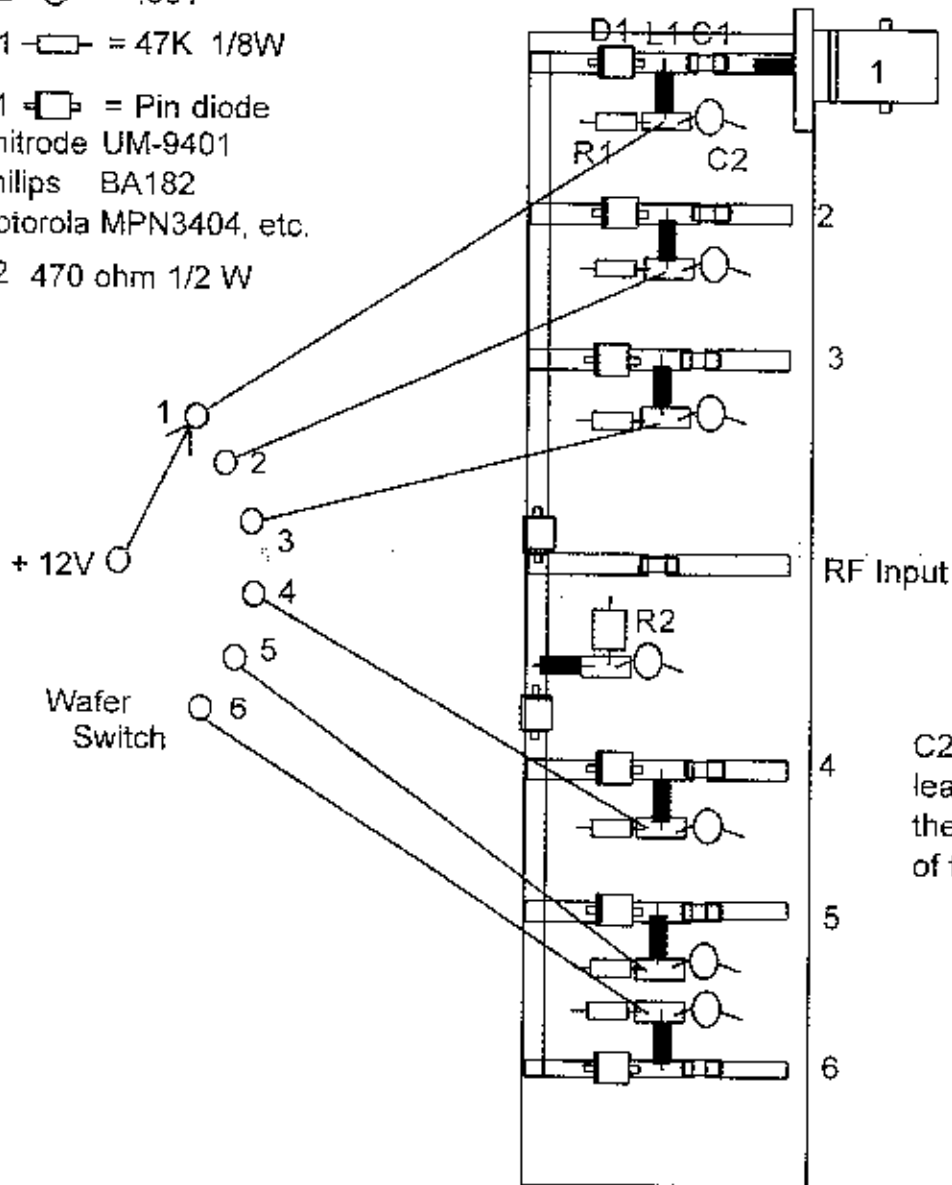

Individual Pin diode switch schematic

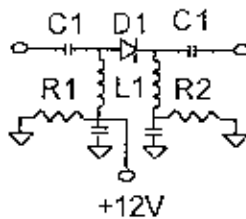

Relay type 6-Position Transverter IF Switch

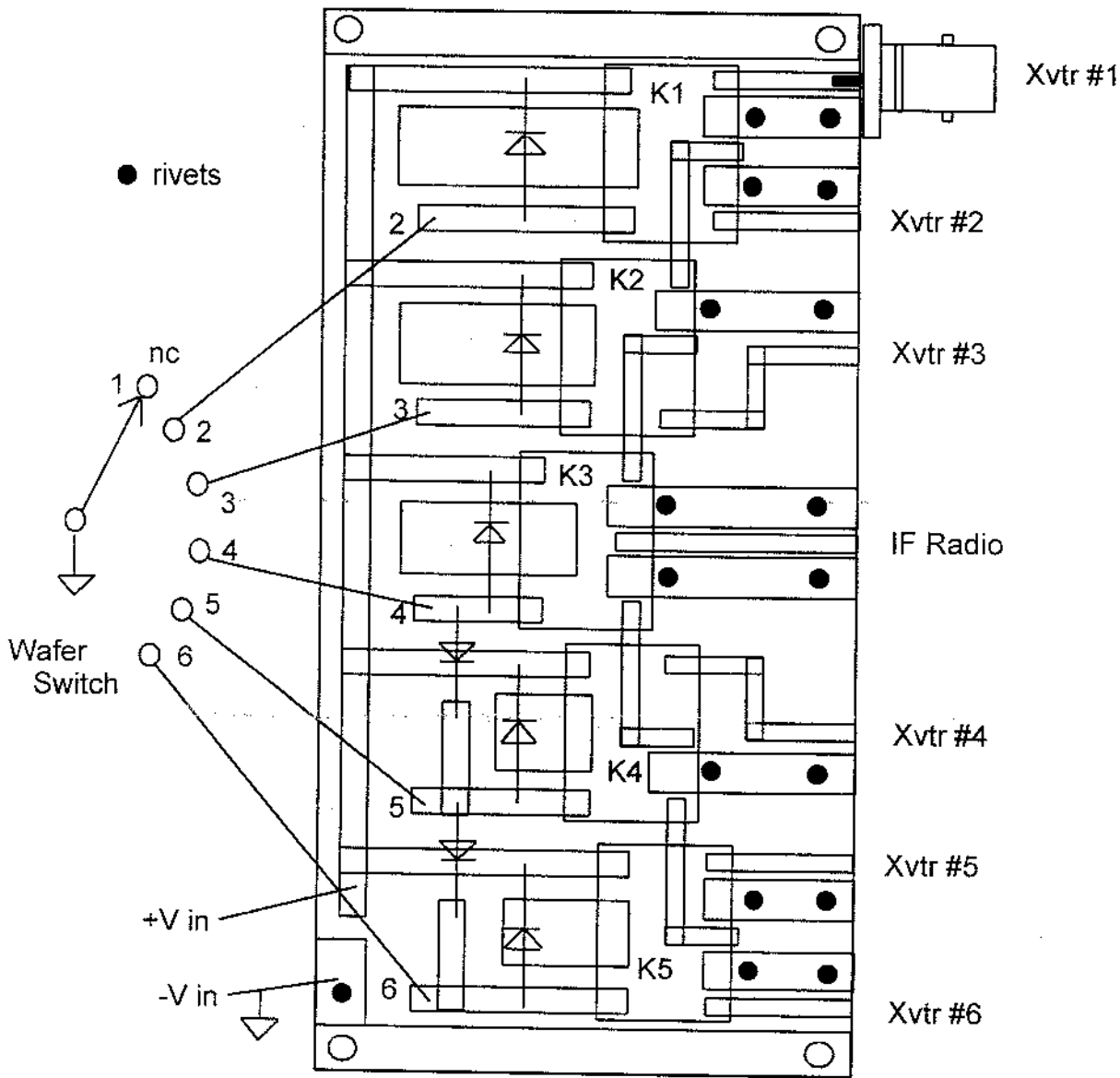

Top side (X-Ray view of etched side)

K1 thru 5 = Omron G4Y-152P (24V) or G5Y-1-DC12

6-Port IF switch		Input Match			
Measured response:		I.L.	Isolation	Return Loss	SWR
Relay type	28 MHz	.05 dB	77 dB	23 dB	1.15:1
Pin Diode type	28 MHz	.35	40	17	1.3:1
Relay type	144 MHz	.05	35	14	1.5:1
Pin Diode type	144 MHz	.43	36	23	1.15:1

Note: The use of the IF post amp dc switch can increase the band-to-band receive IF isolation to >70 dB.

1997 Home Brew Night Entries

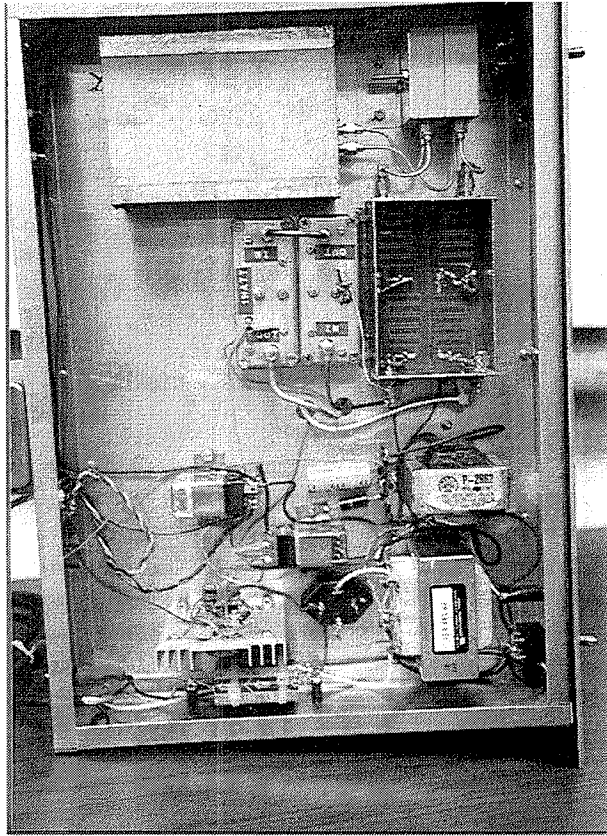

WA3NUF 2304 Mhz Transverter, Bottom View

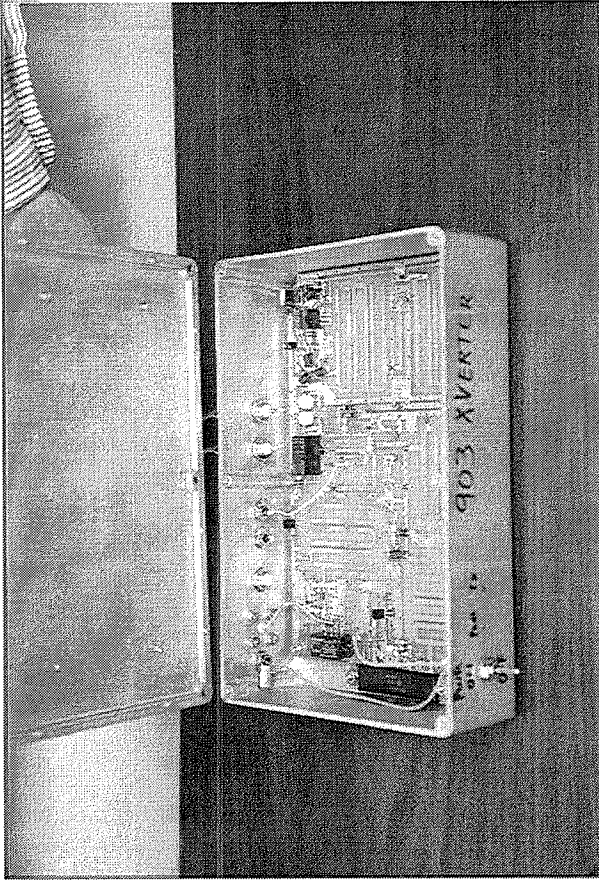

WB3KRW, 903 Mhz Transverter

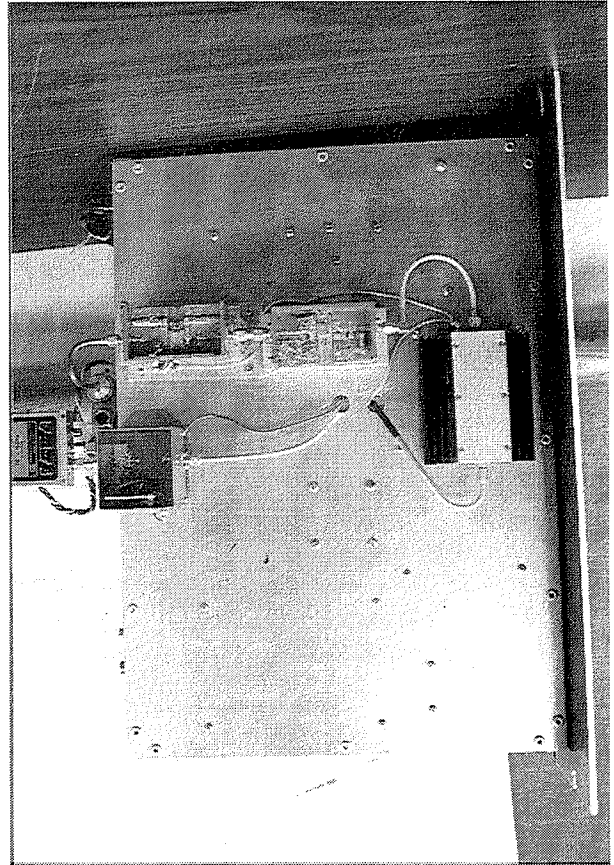

WA3NUF 2304 Mhz Transverter, Top View

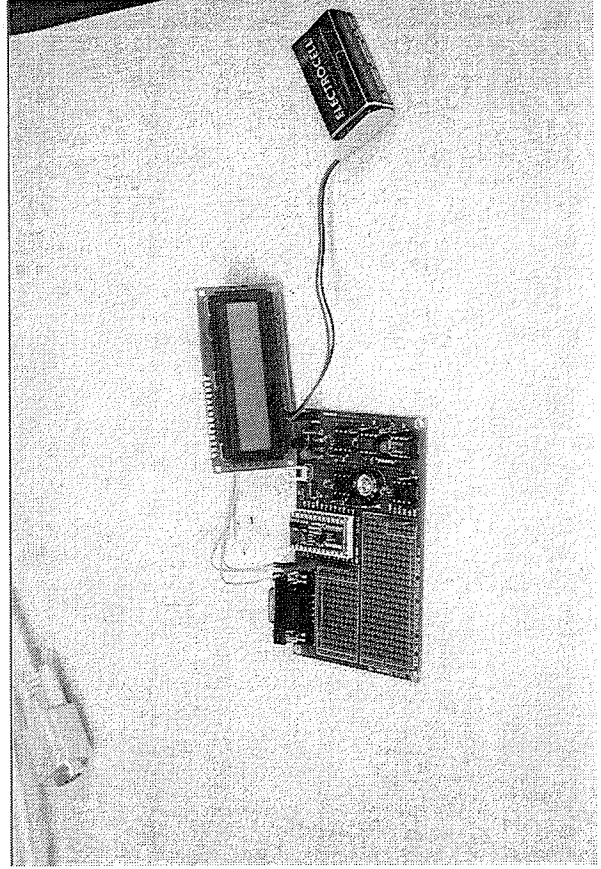

N3NID Digital Degree Logger

1997 Home Brew Night Entries

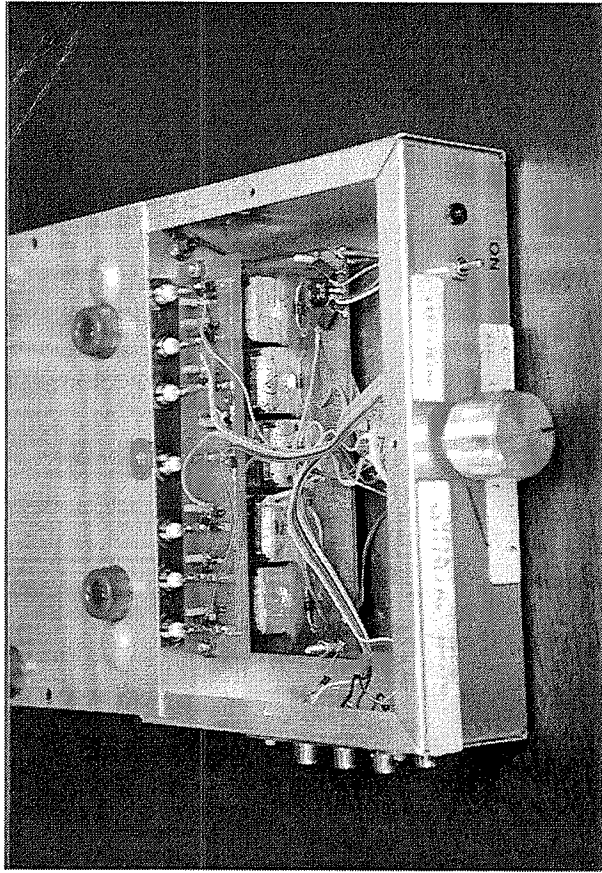

W3KM Multi-Port Xvtr Control/Switch Box

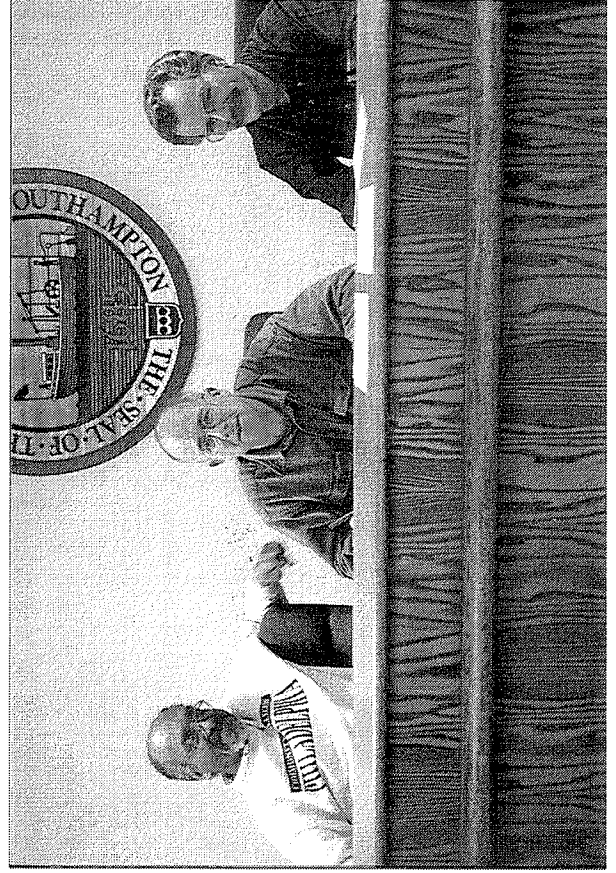

The Judges: Jerome, K3GNC, Rick, WC2K, and Rick, KB3PD

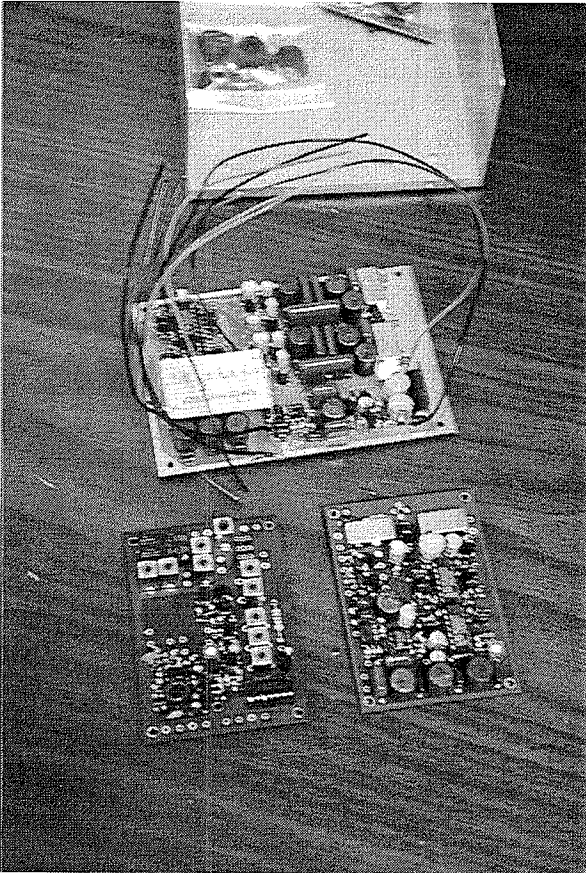

ND8Q QRP Rig

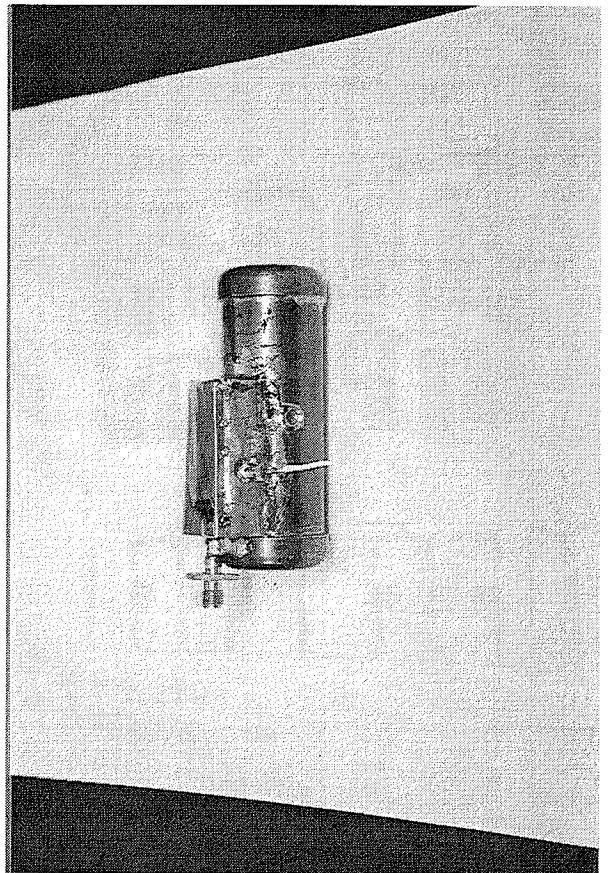

N3NGE 1296 Mhz Cavity Input LNA

(302) 478-2757

Since 1977

AMATEUR & ADVANCED COMMUNICATIONS

Amateur and Shortwave
Closed Sunday & Monday

GISELE
K3WAJ

3208 Concord Pike Rte. 202
Wilmington, Delaware 19803

609-541-0120
FAX 609-541-2546

Bob Fischer Company, Inc.

AERIAL LADDERS · CRANES · MANLIFT EQUIPMENT

BOB FISCHER
PRESIDENT

2765 LINCOLN AVE.
CAMDEN, N. J. 08105



HARRIET SOLTOFF
TRAVEL CONSULTANT

616 SOUTH THIRD STREET
PHILADELPHIA, PA 19147

(215)
RES. 947-4483

THE R. F. CONNECTION

*"Specialist in
RF Connectors and Coax"*

Joel Knoblock
301/840-5477
Fax 301/869-3680

Order Line 800-783-2686
Suite 11, 213 N. Frederick Ave.
Gaithersburg, MD 20877

Graphic Design Illustration Production



Lynne D. Whitsel

209 Frog Hollow Road
Churchville, PA 18966
215 355-5730

RICHARD E. COMLY



TOOL, DIE & MACHINE CO., INC.
2065 BENNETT RD. PHILA., PA 19116

(215) 876-1300
FAX 834-5237



(215) 745-6173
(609) 265-3658
(800) 5-EASY-00



COMPU-SIMPLE, INC.
COMPUTER APPLICATIONS FOR SMALL BUSINESS

ELLIOTT T. WEISMAN
Consultant

P.O. BOX 7161
WILMINGTON, DELAWARE 19803

AUTHORIZED DEALER
ROHN TOWERS

TEL 908-776-2521
FAX 908-776-3835

TELEX-HY-GAIN
ANTENNA SYSTEMS
ROTATORS
TOWERS

PILOT ELECTRIC CO., INC.
1300 HWY. #35
NEPTUNE, N.J. 07763

GENE PILOT



(215) 288-0925

W3HK

GEORGE S. VanDYKE, JR. P.E.

1737 Scattergood Street
Philadelphia, PA 19124

(609) 268-0736

RICHARD CONNOR



RECON Communications

- COMMUNICATIONS TOWER MAINTENANCE
- ANTENNAS, FEEDLINES, TOWERS INSTALLED
- TOWER PAINTING, RE-LAMPING, RE-GUYING
- RF SYSTEM TROUBLESHOOTING
- LIGHTNING PROTECTION, GROUND SYSTEMS

Emergency Service

412 Carranza Road
Tabernacle, NJ 08068

DICK HUNTZINGER
W3FQD
130 FAIRHILL RD.
CHURCHVILLE, PA 18966

12/96

MEETING
NOTICE

Cheese Bits
3012 Potshop Rd.
Norristown, PA 19403

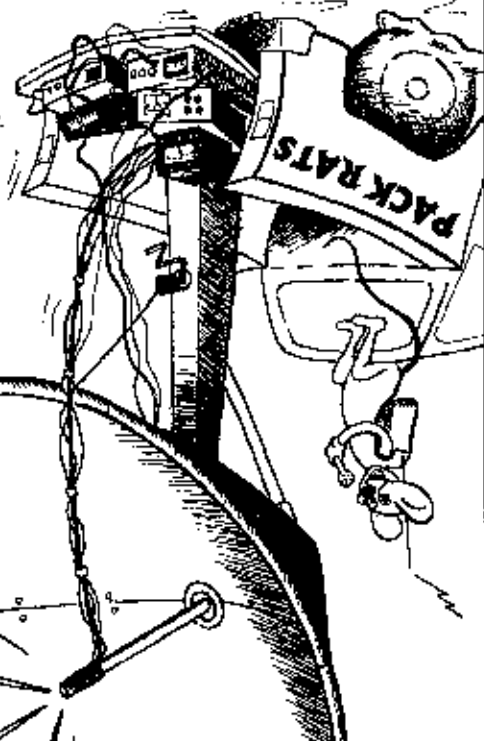

DOWN EAST MICROWAVE

Manufacturers and Distributors
of VHF/UHF/SHF Equipment and Parts
50 to 10,368 MHz

- Microwave Loop Yagis
- VHF/UHF Yagis
- No-Tune Linear Transverters
- Linear Power Amplifiers
- Low Noise Preamps
- Coax Relays, Coax Cable, Connectors
- Crystals, Chip Components, MMICs, Transistors, RF Modules

For All Equipment & Antennas:

Steve Kostro, N2CEI

954 Rt. 519

Frenchtown, NJ 08825

Tel.. 908-996-3584

Fax. 908-996-3702

<http://www.downeastmicrowave.com/Index.html>

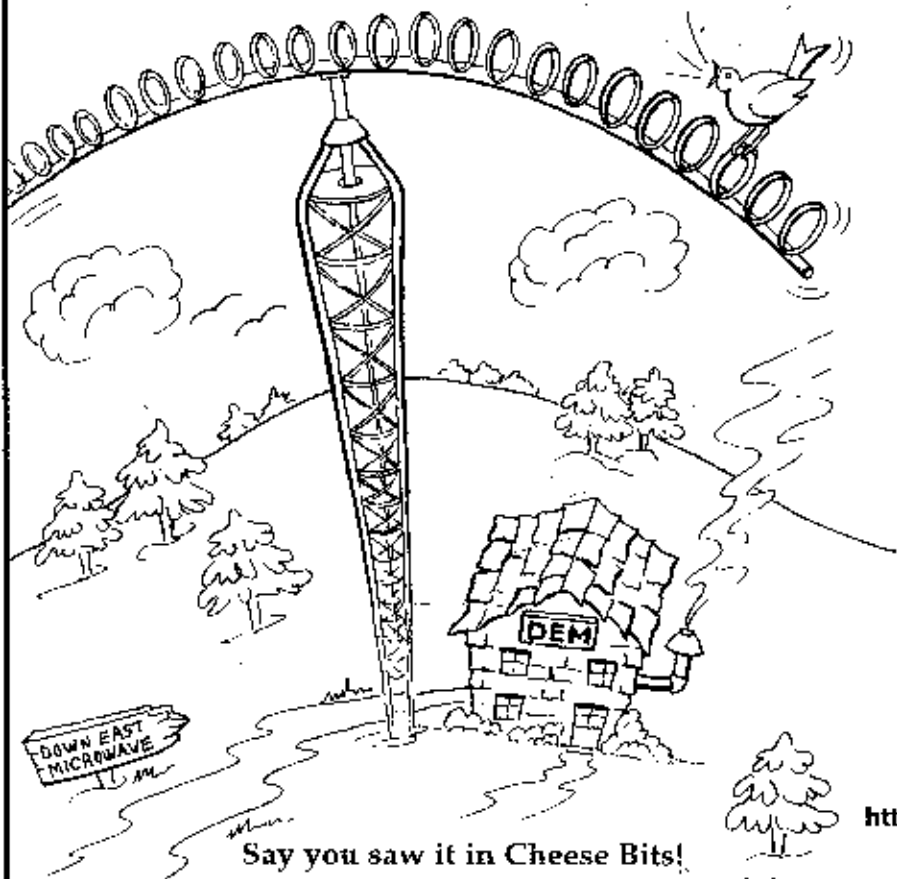

Say you saw it in Cheese Bits!